



SEIKO WATCH CORPORATION
www.grand-seiko.com

JSYGSA04-1807
Printed in Japan



GS
Grand Seiko

Quartz
Operating Instructions

Thank you very much for choosing a Grand Seiko watch.
For proper and safe use of your Grand Seiko watch, please
read the instructions carefully in this booklet before using it.

Keep this manual handy for easy reference.

Bracelet sizing is available at the retailer from whom the watch was purchased. If you cannot have your watch band sized by the retailer from whom the watch was purchased because you received the watch as a gift, or you moved to a distant place, please contact Grand Seiko international service network mentioned on CERTIFICATE OF GUARANTEE or our website. The service may also be available on a chargeable basis at other retailers, however, some retailers may not undertake the service.

The battery in your watch at the time of purchase was inserted in the watch at the factory for performance checks.

Battery replacement is at cost even within the guarantee period.

If your watch has a protective film for preventing scratches, make sure to peel it off before using the watch. If the watch is used with the film on it, dirt, sweat, dust, or moisture may be attached to the film and may cause rust.

CONTENTS

■ HANDLING CAUTIONS	2
■ CHECK THE CALIBER NUMBER AND WATER-RESISTANT LEVEL	3
■ CAUTIONS ON WATER RESISTANCE	4
■ NAMES OF THE PARTS	7
■ HOW TO USE	10
• FOR CAL. 9F83	11
• FOR CAL. 9F82, 9F62	13
• FOR CAL. 9F86	15
※ List of time zone differences in major regions of the world	21
• FOR CAL. 9F61, 4J51	22
• FOR CAL. 4J52	23
• FOR CAL. 8J55	25
■ FUNCTIONS OF DIVER'S MODEL	26
■ TO PRESERVE THE QUALITY OF YOUR WATCH	29
• After-sale service	29
• Guarantee	30
• Daily care	31
• Band	32
• Magnetic resistance (Magnetic influence)	33
• Lumibrite	34
• Troubleshooting	35
■ LEAP SECOND	36
■ SPECIFICATIONS (MOVEMENT)	36

HANDLING CAUTIONS

⚠ WARNING To indicate the risks of serious consequences such as severe injuries unless the following safety regulations are strictly observed.

Immediately stop wearing the watch in the following cases.

- If the watch body or band becomes edged by corrosion etc.
- If the pins protrude from the band.
- ※ Immediately consult the retailer from whom the watch was purchased or Grand Seiko international service network mentioned on CERTIFICATE OF GUARANTEE or our website.

Keep the watch and accessories out of the reach of babies and children.

Care should be taken to prevent a baby or a child accidentally swallowing the accessories. If a baby or child swallows the battery or accessories, immediately consult a doctor, as it will be harmful to the health of the baby or child.

Do not remove the battery from the watch.

Replacement of the battery requires professional knowledge and skill. Please ask the retailer from whom the watch was purchased for battery replacement. Do not recharge the battery, as doing so can generate heat which may cause bursting, leakage or ignition.

⚠ CAUTIONS To indicate the risks of light injuries or material damages unless the following safety regulations are strictly observed.

Avoid wearing or storing the watch in the following places.

- Places where volatile agents (cosmetics such as polish remover, bug repellent, thinners, etc.) are vaporizing.
- Places where the temperature drops below 5 °C or rises above 35 °C for a long time.
- Places of high humidity. Places affected by strong magnetism or static electricity.
- Dusty places. Places affected by strong vibrations.
- ※ Do not leave a dead battery within the watch for a long time as leakage may occur.

If you observe any allergic symptoms or skin irritation

Stop wearing the watch immediately and consult a specialist such as a dermatologist or an allergist.

Other cautions

- Replacement of the metal band requires professional knowledge and skill. Please ask the retailer from whom the watch was purchased for replacement of the metal band, as there is a risk of hand or finger injury and fear of losing parts.
- Do not disassemble or tamper with the watch.
- Keep the watch out of the reach of babies and children. Extra care should be taken to avoid risks of any injury or allergic rash or itching that may be caused when they touch the watch.
- When disposing of used batteries, follow the instructions of your local authorities.
- If your watch is of the fob or pendant type, the strap or chain attached to the watch may damage your clothes, or injure the hand, neck, or other parts of your body.
- Please keep in mind that if a watch is taken off and placed down as it is, the case back, the band and the clasp will rub against each other possibly causing scratches on the case back. We recommend placing a soft cloth between the case back, the band and the clasp after taking off your watch.

CHECK THE CALIBER NUMBER AND WATER-RESISTANT LEVEL

About the caliber number

The caliber number is a four-digit number that indicates the model of a movement (mechanical part of a watch). The Grand Seiko watch is mounted with an exclusive movement. The mechanical caliber number starts with "9S" the spring drive caliber number starts with "9R" and the quartz caliber number starts with "9F" and "4J".

How to check the caliber number

The four-digit model number on the case back is the caliber number.

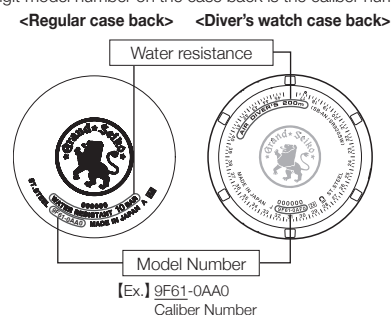

※ The above illustrations are examples and may differ from the case back of the watch you purchased.

Water resistance

Refer to the table below for the description of each degree of water resistant performance of your watch before using.

Indication on the case back	Water resistant performance	Conditions of Use
No indication	Non-water resistance	Avoid drops of water or sweat
WATER RESISTANT	Water resistance for everyday life	The watch withstands accidental contact with water in everyday life ⚠ WARNING Not suitable for swimming
WATER RESISTANT 5 BAR	Water resistance for everyday life at 5 barometric pressures	The watch is suitable for swimming.
WATER RESISTANT 10 (20) BAR	Water resistance for everyday life at 10 (20) barometric pressures	The watch is suitable for diving not using an air cylinder.
AIR DIVER'S 200m	The watch can be worn for diving using a compressed air cylinder and can withstand water pressure to a depth of 200 meters.	The watch is suitable for genuine scuba diving use.

CAUTIONS ON WATER RESISTANCE

⚠ CAUTIONS



Do not turn or pull out the crown when the watch is wet.

Water may get inside of the watch.

※ If the inner surface of the glass is clouded with condensation or water droplets appear inside of the watch for a long time, the water resistant performance of the watch is deteriorated. Immediately consult the retailer from whom the watch was purchased or Grand Seiko international service network mentioned on CERTIFICATE OF GUARANTEE or our website.



Do not leave moisture, sweat and dirt on the watch for a long time.

Be aware of a risk that a water resistant watch may lessen its water resistant performance because of deterioration of the adhesive on the glass or gasket, or the development of rust on stainless steel.



Do not wear the watch while taking a bath or a sauna.

Steam, soap or some components of a hot spring may accelerate the deterioration of water resistant performance of the watch.

If water-resistant level of your watch is defined as "WATER RESISTANT"

⚠ WARNING



Do not use the watch in scuba diving or saturation diving.

The various tightened inspections under simulated harsh environment, which are usually required for watches designed for scuba diving or saturation diving, have not been conducted on the water-resistant watch with the BAR (barometric pressure) display. For diving, use special watches for diving.

⚠ CAUTION



Do not pour running water directly from the faucet.

The water pressure of tap water from a faucet is high enough to degrade the water resistant performance of a water resistant watch for everyday life.

If water-resistant level of your watch is defined as "AIR DIVER'S"

⚠ WARNING

- Never use the watch in saturation diving using helium gas.
- While diving, never operate the watch in any other manner than described in this instruction manual.

⚠ CAUTION

Before using the diver's watch, you have to be properly trained in various types of diving and possess the requisite experience and skill to dive safely. When diving, strictly abide by the rules of diving.

Precautions for diving

○ Before diving

Inspect the following items before diving.

⇒ "NAMES OF THE PARTS" page 9.

- ① The time is correctly set.
- ② The rotating bezel turns smoothly.
(The bezel rotation must not be too loose or too tight.)
⇒ "Unidirectional rotating bezel" page 26.
- ③ The crown is completely screwed in.
⇒ "Screw down crown" page 10.
- ④ No abnormalities such as flaws or cracks exist on the band or glass.
- ⑤ The band is reliably fixed with spring bars, buckles or other parts.

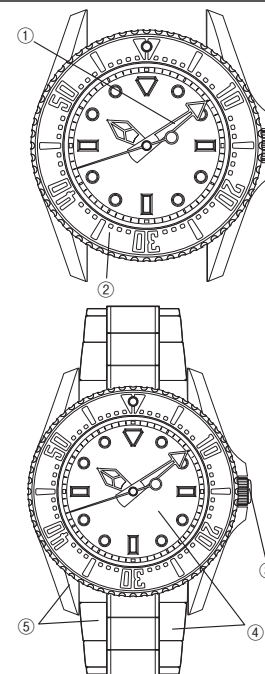

⚠ CAUTION

If you notice any abnormalities, contact the retailer from whom the watch was purchased or Grand Seiko international service network mentioned on CERTIFICATE OF GUARANTEE or our website.

○ **While diving**

Make sure to observe the following instructions when you wear the watch while diving.



Wear the watch within the water depth indicated on the dial.



Do not operate the crown or buttons underwater.



Take care not to bump the watch against hard objects such as rocks.



Bezel rotation may become slightly harder underwater, but this is not a malfunction.

○ **After diving**

Please follow the care instructions below after diving.

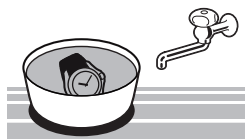

Rinse the watch in fresh water and wipe it thoroughly dry. Do not pour running water directly from a faucet onto the watch. Soak the watch in a container filled with water to wash it.



■ **NAMES OF THE PARTS**

9F83

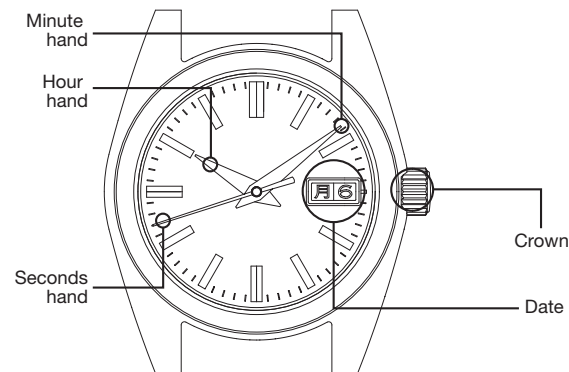

⇒ "How to set the time, date and day" page 11.

9F82, 9F62, 4J52

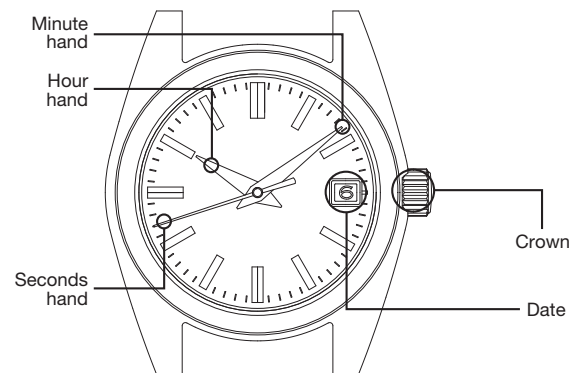

⇒ "How to set the time and date" for Cal. 9F82, 9F62 page 13.
 ⇒ "How to set the time" for Cal. 4J52 page 23.

9F86

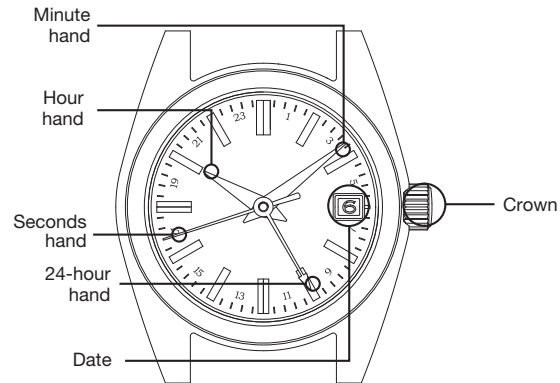

⇒ "How to set the time and date" page 15.

9F61 (Diver's models)

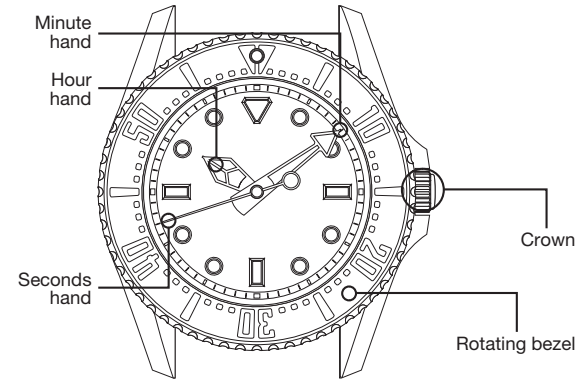

⇒ "How to set the time" page 22.
⇒ "FUNCTIONS OF DIVER'S MODEL" page 26.
⇒ "Precautions for diving" page 5.

9F61, 8J55, 4J51

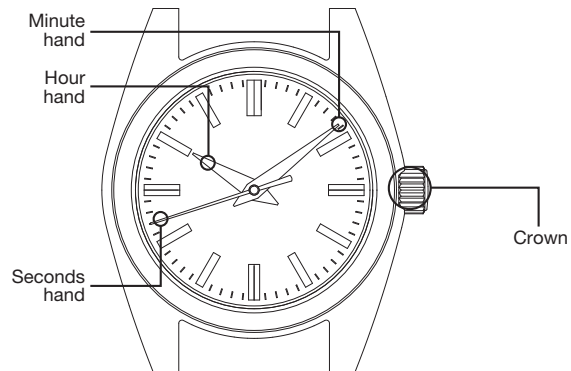

⇒ "How to set the time" for Cal. 9F61, 4J51 page 22.
⇒ "How to set the time" for Cal. 8J55 page 25.

HOW TO USE

Crown

There are two types of crowns; a normal crown and a screw down crown.

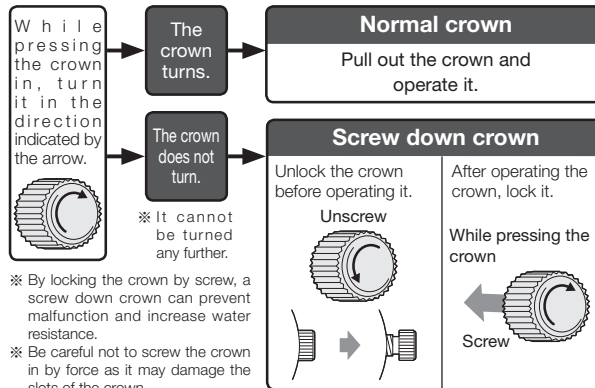

Screw down crown

The screw down crown features a mechanism that can securely lock the crown when they are not being operated in order to prevent any operational errors and to improve its water resistant property.

- It is necessary to unlock the screw down crown before operating it.
- Once you have finished operating the crown, make sure to relock it.

[To unlock the crown]

Turn the crown counterclockwise (6 o'clock direction) to unscrew it. Now the crown can be operated.

[To lock the crown]

Turn the crown clockwise (12 o'clock direction) while gently pressing it in toward the watch body until it stops.

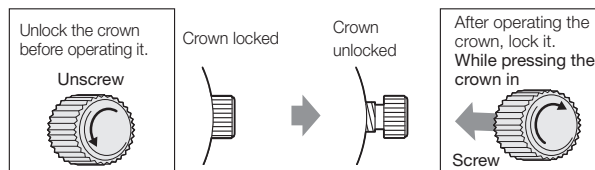

※ When locking the crown, turn it slowly with care, ensuring that the screw is properly engaged. Be careful not to push it in forcefully, as doing so may damage the screw hole in the case.

HOW TO USE (FOR CAL. 9F83)

⚠ CAUTION

You may not be able to set the date and/or day when the time on your watch is between midnight and 1:00 a.m. due to the mechanism of the watch. This is not a malfunction.
 Please refrain from setting the date and/or day during this time.

How to set the time, date and day

- ① First, set the date and day. Pull out the crown to the first click. The seconds hand keeps moving.

- ② Turn the crown until the previous day's date and day of the week appear.

Turn the crown counterclockwise (6 o'clock direction) to advance the date. Turn the crown clockwise (12 o'clock direction) to advance the day of the week. The language of day indication changes between Japanese and English alternately.

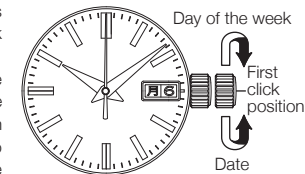

- ③ Pull out the crown to the second click when the seconds hand is at the 12 o'clock position. The seconds hand stops on the spot. Turn the crown counterclockwise (6 o'clock direction) to advance the hands until the desired date appears.

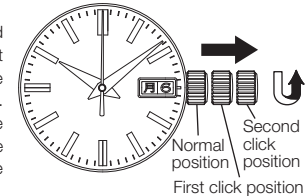

- ④ When setting the hour hand, check that a.m./p.m. is correctly set, as the date is designed to change once in 24 hours.

Due to the mechanism of the quartz watch, to set the time accurately, first turn the minute hand 4 to 5 minutes ahead of the desired time and then return it to the correct time.

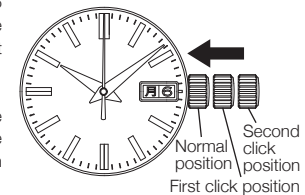

- ⑤ Push the crown back into the normal position in accordance with a time signal. The watch immediately starts moving.

Date adjustment at the end of the month

It is necessary to adjust the date after February (which has 28 days, 29 days in a leap year) and a 30 day month.

[Ex.] To adjust the date in the a.m. period on the first day of a month following a 30-day month. The watch displays "31" instead of "1". Pull out the crown to the first click. Turn the crown counterclockwise (6 o'clock direction) to set the date to "1".

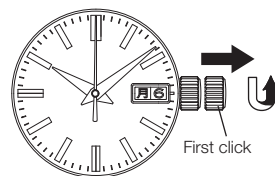

Instantly changing date and day

This watch is able to change the date and day of the week indication instantly between 0:00 a.m. and 0:05 a.m. In case of conventional quartz watches, the date and day of the week indication change gradually between 9:00 p.m. and 3:00 a.m.

※ Instantly changing the date and time may not be possible, depending on how the time is set.

If the time you want to set is between 7:00 p.m. and 1:00 a.m., first return the time to 6:00 p.m., and then turn the crown counterclockwise (6 o'clock direction) so the hands advance in the clockwise direction to set the time.

HOW TO USE (FOR CAL. 9F82, 9F62)

⚠ CAUTION

You may not be able to set the date when the time on your watch is between midnight and 1:00 a.m. due to the mechanism of the watch. This is not a malfunction.

Please refrain from setting the date and/or day during this time.

How to set the time and date

① First, set the date. Pull out the crown to the first click. The seconds hand keeps moving.

② The date can be set by turning the crown counterclockwise (6 o'clock direction). First turn the crown until the previous day's date from the desired date appears.

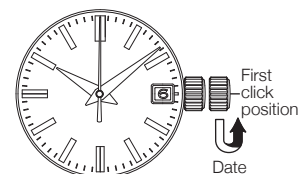

③ Pull out the crown to the second click when the seconds hand is at the 12 o'clock position. The seconds hand stops on the spot. Turn the crown counterclockwise (6 o'clock direction) to advance the hands until the desired date appears.

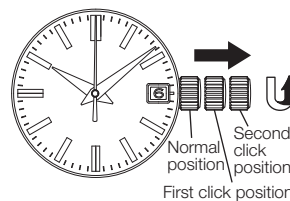

④ When setting the hour hand, check that a.m./p.m. is correctly set, as the date is designed to change once in 24 hours.

Due to the mechanism of the quartz watch, to set the time accurately, first turn the minute hand 4 to 5 minutes ahead of the desired time and then return it to the correct time.

⑤ Push the crown back into the normal position in accordance with a time signal. The watch immediately starts moving.

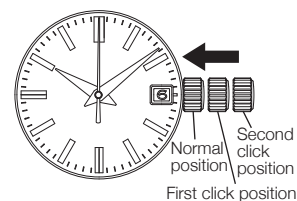

Date adjustment at the end of the month

It is necessary to adjust the date after February (which has 28 days, 29 days in a leap year) and a 30 day month.

【Ex.】 To adjust the date in the a.m. period on the first day of a month following a 30-day month

The watch displays "31" instead of "1". Pull out the crown to the first click. Turn the crown counterclockwise (6 o'clock direction) to set the date to "1".

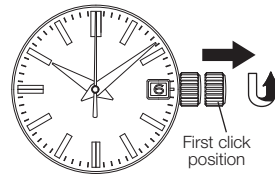

Instantly changing date

This watch is able to change the date indication instantly between 0:00 a.m. and 0:05 a.m. In case of conventional quartz watches, the date indication changes gradually between 9:00 p.m. and 3:00 a.m.

※ Instantly changing the date and time may not be possible, depending on how the time is set.

If the time you want to set is between 7:00 p.m. and 1:00 a.m., first return the time to 6:00 p.m., and then turn the crown counterclockwise (6 o'clock direction) so the hands advance in the clockwise direction to set the time.

HOW TO USE (FOR CAL. 9F86)

How to set the time and date

- To set the time and date, set the 24-hour hand and minute hand first, and then set the hour hand and date.

- ① Pull out the crown to the second click when the seconds hand is at the 12 o'clock position. (The seconds hand stops on the spot.)
(If the watch is equipped with the screw down crown, unscrew the crown before pulling it out.)

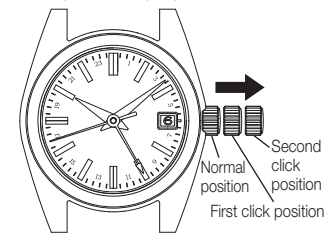

- ② Turn the crown counterclockwise (6 o'clock direction) to rotate the 24-hour hand and minute hand clockwise and set them to the current time. Due to the mechanism of the quartz watch, to set the time accurately, first turn the minute hand 4 to 5 minutes ahead of the desired time and then return it to the correct time.

※ Only the 24-hour and minute hands are to be set first. Even if the hour hand is indicating incorrect time, or the date may be altered depending on the position of the hour hand, it is not necessary to make an adjustment at this stage.

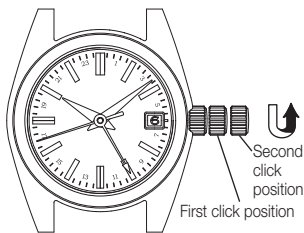

- ③ Push the crown back in simultaneously with the time signal.

※ The setting of the 24-hour, minute and seconds hands is now completed.

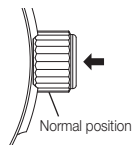

- ④ To move on to the hour hand and date setting, pull the crown out to the first click.

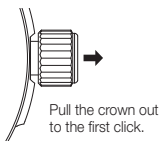

- ⑤ Turn the crown to set the hour hand. While turning the crown, the moment the date changes is midnight. When setting the hour hand, be sure that AM/PM is set correctly. Set the date also at this point if necessary.

※ The crown can be turned in either direction to set the date, however, it is recommended to turn the crown in the direction which enables you to set the date with a smaller adjustment.
 ※ If the time you want to set is between 7:00 p.m. and 1:00 a.m., first return the time to 6:00 p.m., and then turn the crown counterclockwise (6 o'clock direction) so the hands advance in the clockwise direction to set the time.
 ※ Turn the crown slowly, checking that the hour hand moves in one-hour increments.
 ※ When setting the hour hand, the other hands may move slightly. However, this is not a malfunction.

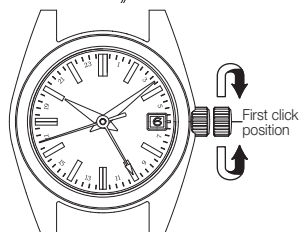

- ⑥ Push the crown back in to complete the time setting. (If the watch is equipped with the screw down crown, relock the crown.)

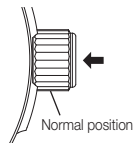

Date adjustment at the end of the month

It is necessary to adjust the date after February (which has 28 days, 29 days in a leap year) and a 30 day month. Two full rotations of the hour hand will change the date for one day. The date advances one day by turning the hour hand two full rotations clockwise (for 24 hours).

- ① Pull out the crown to the first click. (If the watch is equipped with the screw down crown, unscrew the crown before pulling it out.)

- ② Each time the hour hand makes two full rotations by turning the crown, the date is adjusted one day. While turning the crown, the moment the date changes is midnight. When setting the hour hand, be sure that a.m./p.m. is set correctly.

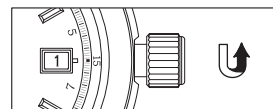
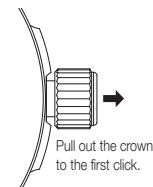

Turning the crown counterclockwise (6 o'clock direction):
 Each time the hour hand makes two full rotations, the date is advanced one day.

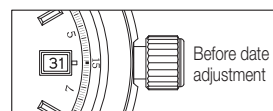

※ The crown can be turned in either direction to set the date, however, it is recommended to turn the crown in the direction which enables you to set the date with a smaller adjustment.
 ※ Turn the crown slowly.
 ※ When setting the hour hand, the other hands, the other hands may move slightly. However, this is not a malfunction.

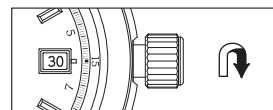

Turning the crown clockwise (12 o'clock direction):
 Each time the hour hand makes two full rotations, the date is set back one day.

- ③ Upon completion of setting, make sure that the time indicated is correct, and then push the crown back in. The date setting is now completed. (If the watch is equipped with the screw down crown, relock the crown.)

- ※ The date is designed to work in conjunction with the movement of the hour hand, therefore, incorrect setting of a.m./p.m. will cause the date to change at noon.
- ※ The crown can be turned in either direction to set the date, however, it is recommended to turn the crown in the direction which enables you to set the date with a smaller adjustment.
- ※ If the time you want to set is between 7:00 p.m. and 1:00 a.m., first return the time to 6:00 p.m., and then turn the crown counterclockwise (6 o'clock direction) so the hands advance in the clockwise direction to set the time.
- ※ Turn the crown slowly, checking that the hour hand moves in one-hour increments.
- ※ When setting the hour hand, the other hands may move slightly. However, this is not a malfunction.

How to use the 24-hour hand

This watch has two different types of 24-hour hand usage.

<Type 1> 24-hour hand as an a.m./p.m. indicator

Simply using the 24-hour hand to show the 24-hour time as an a.m./p.m. indicator. (This is the standard usage type for the 24-hour hand.)

Both the hour hand and the 24-hour hand are indicating the Japan time 10:00 a.m.



<Type 2> 24-hour hand as a dual time indicator

Using the time difference adjustment function, set the 24-hour hand to indicate a time different from the time that the hour and minute hand indicate, which is of a place in a different time zone area with at least one hour of time difference from where you are.

Hour hand: Japan time 10:00 a.m.
24-hour hand: New York time 8:00 p.m.



Time difference adjustment function

For example, while traveling abroad and staying in a place with a different time from where you live, you can conveniently set the watch to indicate the local time in the different time zone area without stopping the watch.

The hour hand indicates the time of the place where you currently are, while the 24-hour hand indicates the time of the place of origin.

The date works in conjunction with the movement of the hour hand. If the time difference is correctly adjusted, the watch displays the correct date of the place where you are staying.

How to use the time difference adjustment function

- ① Pull out the crown to the first click. (If the watch is equipped with the screw down crown, unscrew the crown before pulling it out.)

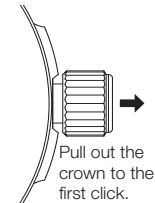

- ② Turn the crown to set the hour hand to indicate the time of the place where you are staying. Make sure that a.m./p.m. and date are correctly set.
 - ※ The date is designed to work in conjunction with the movement of the hour hand, therefore, incorrect setting of a.m./p.m. will cause the date to change at noon.
 - ⇒ "List of time zone differences in major regions of the world" page 21.

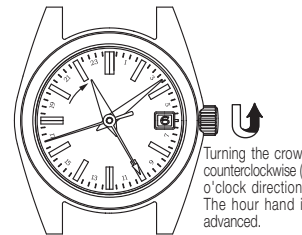

Turning the crown counterclockwise (6 o'clock direction): The hour hand is advanced.

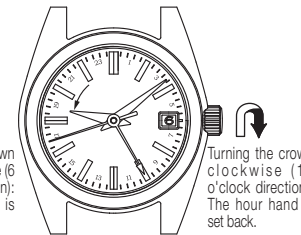

Turning the crown clockwise (12 o'clock direction): The hour hand is set back.

- ※ Turn the crown slowly, checking that the hour hand moves in one-hour increments.
- ※ While turning the crown, the moment the date changes is midnight.
- ※ When setting the hour hand, the other hands may move slightly. However, this is not a malfunction.

- ③ Upon completion of setting, make sure that the time indicated is correct, and then push the crown back in. The setting procedure is now completed. (If the watch is equipped with the screw down crown, relock the crown.)

※ If the time you want to set is between 7:00 p.m. and 1:00 a.m., first return the time to 6:00 p.m., and then turn the crown counterclockwise (6 o'clock direction) so the hands advance in the clockwise direction to set the time.

Selectable display mode

With the time difference adjustment function, the watch features a dual time display which shows time in two different time zones. It offers two display modes which you can select to suit your needs and preference.

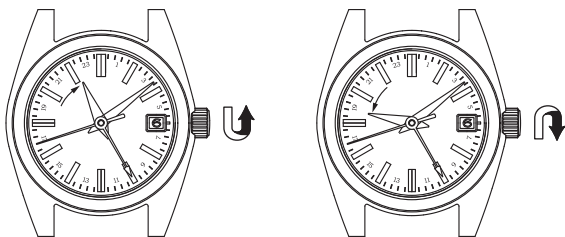

[Ex.1]

Hour hand and date: Area A (Japan)
24-hour hand: Area B (New York)

[Ex.2]

Hour hand and date: Area B (New York)
24-hour hand: Area A (Japan)

Set the 24-hour hand first, and then set the hour hand.

Instantly changing date

This watch is able to change the date indication instantly between 0:00 a.m. and 0:05 a.m. In case of conventional quartz watches, the date indication changes gradually between 9:00 p.m. and 3:00 a.m.

※ Instantly changing the date and time may not be possible, depending on how the time is set.

If the time you want to set is between 7:00 p.m. and 1:00 a.m., first return the time to 6:00 p.m., and then turn the crown counterclockwise (6 o'clock direction) so the hands advance in the clockwise direction to set the time.

List of time zone differences in major regions of the world

Names of the cities	UTC ± (Hours)	JST ± (Hours)	Other cities in the same region
Tokyo	+9:00	±0:00	Seoul
Beijin	+8:00	-1:00	Hong Kong, Manila, Singapore
Bangkok	+7:00	-2:00	Jakarta
Dacca	+6:00	-3:00	
Karachi	+5:00	-4:00	Tashkent
Dubai	+4:00	-5:00	
Jeddah	+3:00	-6:00	Nairobi, Mecca
Cairo	+2:00	-7:00	★Athens
★Paris	+1:00	-8:00	★Rome, ★Berlin, ★Madrid
★London	±0:00	-9:00	★Casablanca
★Azores	-1:00	-10:00	
★Rio de Janeiro	-3:00	-12:00	
Santo Domingo	-4:00	-13:00	
★New York	-5:00	-14:00	★Montreal
★Chicago	-6:00	-15:00	★Mexico City
★Denver	-7:00	-16:00	
★Los Angels	-8:00	-17:00	★San Francisco
★Anchorage	-9:00	-18:00	
Honolulu	-10:00	-19:00	
Midway Island	-11:00	-20:00	
★Wellington	+12:00	+3:00	Fiji
Nouméa	+11:00	+2:00	
★Sydney	+10:00	+1:00	Guam

※ UTC = Coordinated Universal Time / JST = Japan Standard Time

※ Regions marked with ★ use daylight saving time

※ The time zone differences and use of daylight saving time in each city are based on data as of January, 2018. These are subject to change according to the governments of the respective countries or regions.

HOW TO USE (FOR CAL. 9F61, 4J51)

How to set the time

- ① Pull out the crown when the seconds hand is at the 12 o'clock position as shown in the illustration. The seconds hand stops on the spot.

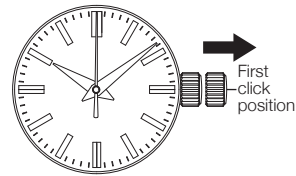

- ② Turn the crown to set the hands to the desired time. Due to the mechanism of the quartz watch, to set the time accurately, first turn the minute hand 4 to 5 minutes ahead of the desired time and then return it to the correct time.

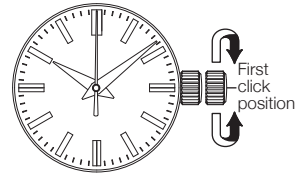

- ③ Push the crown back into the normal position in accordance with a time signal. The watch immediately starts moving.

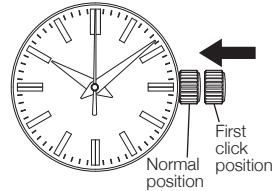

HOW TO USE (FOR CAL. 4J52)

⚠ CAUTION

If you set the date when the time on your watch is between 9:00 p.m. and 3:00 a.m., the date may not change correctly on the following day due to the mechanism of the watch. Please refrain from setting the date during this time.

How to set the time

- ① First, set the date. Pull out the crown to the first click. The seconds hand keeps moving.

- ② The date can be set by turning the crown counterclockwise (6 o'clock direction). First turn the crown until the previous day's date from the desired date appears.

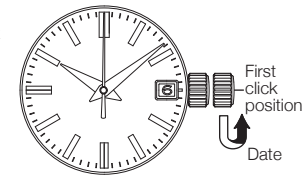

- ③ Pull out the crown to the second click when the seconds hand is at the 12 o'clock position. The seconds hand stops on the spot. Turn the crown counterclockwise (6 o'clock direction) to advance the hands until the desired date appear.

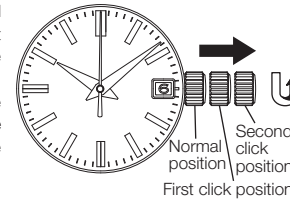

- ④ Turn the crown to set the hour and minute hands to the desired time. When setting the hour hand, be sure to check that a.m./p.m. is correctly set. The watch is designed so that the date changes once in 24 hours. When setting the minute hand, first advance it 4 to 5 minutes ahead of the desired time and then turn it back to the exact minute.

- ⑤ Push the crown back into the normal position in accordance with a time signal. The watch immediately starts moving.

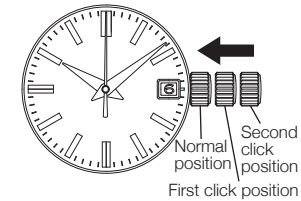

Date adjustment at the end of the month

It is necessary to adjust the date after February (which has 28 days, 29 days in a leap year) and a 30 day month.

[Ex.] To adjust the date in the a.m. period on the first day of a month following a 30-day month.

The watch displays "31" instead of "1". Pull out the crown to the first click. Turn the crown to set the date to "1".

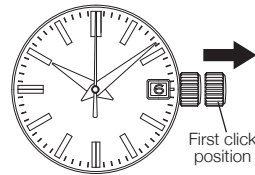

HOW TO USE (FOR CAL. 8J55)

This watch features a time difference adjustment function. The hour hand can be easily adjusted in one-hour increments without stopping the minute and seconds hands. This function is convenient especially when traveling abroad.

English

How to use the independent hour-hand adjustment function

① Pull out the crown to the first click. The seconds hand keeps moving.

② Turn the crown clockwise (12 o'clock direction) to advance the hour hand. Turn the crown counterclockwise (6 o'clock direction) to set the hour hand back. The hour hand moves in one-hour increments.

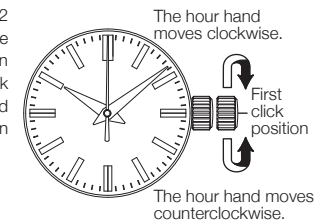

How to set the time

③ After adjusting the hour hand position, pull out the crown to the second click when the seconds hand is at the 12 o'clock position. The seconds hand stops on the spot.

④ Turn the crown to set the hour and minute hands to the desired time. When setting the minute hand, first advance it 4 to 5 minutes ahead of the desired time and then turn it back to the exact minute.

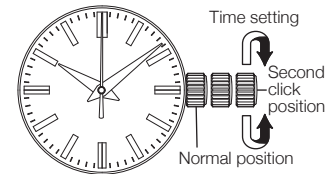

⑤ Complete the procedure by pushing the crown back into the normal position in accordance with a time signal.

FUNCTIONS OF DIVER'S MODEL

Unidirectional rotating bezel

By using the rotating bezel, you can measure the elapsed time since the start of an event or an activity such as diving.

This watch has a unidirectional rotating bezel. As the evaluation of the remaining air in your cylinder is based on the information of the elapsed time of the dive, the rotating bezels for a diver's watch is designed to rotate only counterclockwise, so that the watch is prevented from displaying the elapsed time shorter than it actually is.

CAUTION Make sure that you check the correct remaining amount of air in your cylinder before diving. Use the display of the elapsed time by the rotating bezel only as a guide during diving.

How to use the rotating bezel

- ① At the start of the activity, for which you want to measure the elapsed time (for example, when you start diving), rotate the bezel so that the  mark on the bezel is aligned with the minute hand.
- ② Read the graduation on the rotating bezel to which the minute hand is pointing.

[Ex.] When you start diving at 10:10.

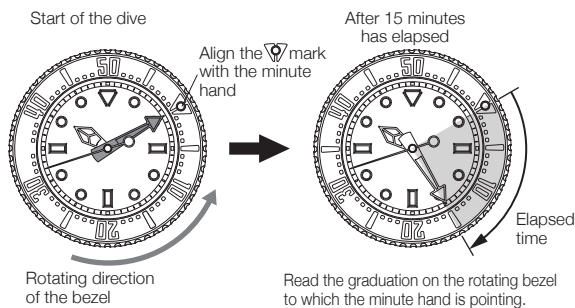

Slide adjuster

If your watch has a metal bracelet equipped with a slide adjuster mechanism, you can easily adjust the bracelet length by yourself. This is very useful when you wear the watch over a wetsuit or a heavy winter clothing.

How to use the slide adjuster

- ① Lift up the flap approximately 90° and press it down further approximately 20°, and hold it there.
 - ※ You may feel slight resistance, but doing this requires only a light force. Please do not push the flap down forcibly.
- ② Lightly pull the bracelet on the 6 o'clock side of the watch along the curved line of the bracelet.
 - ※ Again, doing this requires only a light force. Please do not pull the bracelet forcibly.
 - ※ The slider can be pulled out approximately 30 mm. Be careful not to pull it out beyond the limit mark inscribed on it.

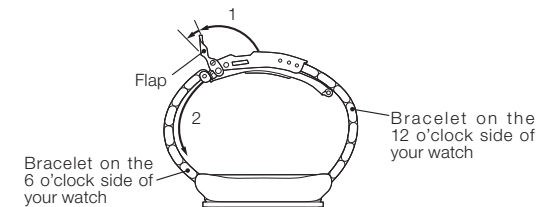

- ③ Holding down the push button, lift up the clasp to release the buckle, and strap the watch on your wrist.
- ④ Close the clasp first and then, the flap.
- ⑤ With the hand which is not wearing the watch, adjust the length of the slider so that the watch fits well around your wrist.

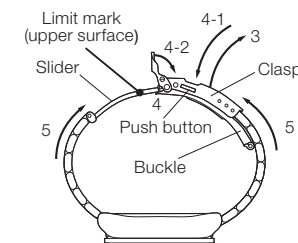

Battery replacement period indication

As a guide to the battery replacement period, a battery life indicator is engraved on the case back of the watch as shown in the diagram below. At the time of purchase of the watch, the first battery replacement period is indicated by an engraved circle mark.

How to identify the battery replacement period indicator

[Ex.] The battery replacement period is from July to September of 2017.

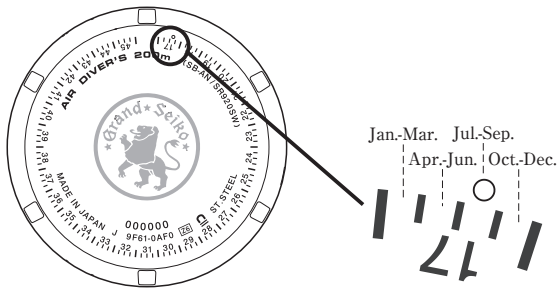

- Arabic numerals on the scale show the last two digits of the year.
- For subsequent battery replacements, a circle mark will be engraved each time a watch is returned to an authorized Grand Seiko retailer for battery replacement or watch repair.

TO PRESERVE THE QUALITY OF YOUR WATCH

After-sale service

Notes on guarantee and repair

- Contact the retailer from whom the watch was purchased or Grand Seiko international service network mentioned on CERTIFICATE OF GUARANTEE or our website for repair or overhaul.
- Within the guarantee period, present the certificate of guarantee to receive repair services.
- Guarantee coverage is provided in the certificate of guarantee. Read carefully and retain it.
- For repair services after the guarantee period has expired, if the functions of the watch can be restored by repair work, we will undertake repair services upon request and payment.

Replacement parts

- Please keep in mind that if original parts are not available, they may be replaced with substitutes whose outward appearance may differ from the originals.

Inspection and adjustment by disassembly and cleaning (overhaul)

- Periodic inspection and adjustment by disassembly and cleaning (overhaul) is recommended approximately once every 3 to 4 years in order to maintain optimal performance of the watch for a long time. According to use conditions, the oil retaining condition of your watch mechanical parts may deteriorate, abrasion of the parts may occur due to contamination of oil, which may ultimately lead the watch to stop. As the parts such as the gasket may deteriorate, water-resistant performance may be impaired due to intrusion of perspiration and moisture. Please contact the retailer from whom the watch was purchased for inspection and adjustment by disassembly and cleaning (overhaul). For replacement of parts, please specify "GRAND SEIKO GENUINE PARTS". When asking for inspection and adjustment by disassembly and cleaning (overhaul), make sure that the gasket and push pin are also replaced with new ones.
- When your watch is inspected and adjusted by disassembly and cleaning (overhauled), the movement of your watch may be replaced.

Guarantee

Within the guarantee period, we guarantee free repair/adjustment service against any defects according to the following guarantee regulations, provided that the watch was properly used as directed in this instruction booklet.

Guarantee coverage

The watch body (movement, case) and metallic band.

Exceptions from guarantee

In following cases, repair/adjustment services will be provided at cost even within the guarantee period or under guarantee coverage.

- Exchange of leather, urethane, or fabric band.
- Troubles or damage to the case, glass, or band, caused by accidents or improper usage.
- Scratches or grime caused by use.
- Troubles and damage caused by acts of God, natural disasters including fire, floods or earthquakes.
- Text in certificate has been altered.
- No certificate is presented.

Procedure to claim free repair services

- For any defects under guarantee, submit the watch together with the attached certificate of guarantee to the retailer from whom the watch was purchased.
- In the case where you cannot accept the guarantee from the retailer from whom the watch was purchased due to gift-giving or relocation, etc., ask Grand Seiko international service network mentioned on CERTIFICATE OF GUARANTEE or our website by attaching the certificate without fail.

Others

- For the watch case, dial plate, hands, glass, band, etc., some alternative parts may be used for repair if necessary. Refer to page 29 of this booklet "Replacement parts".
- For length adjustment service of metallic band, ask the retailer from whom the watch was purchased or Grand Seiko international service network mentioned on CERTIFICATE OF GUARANTEE or our website. Other retailers may undertake the service on a chargeable basis or may not undertake the service.
- Free repair services are guaranteed only under the period and conditions specified in the certificate of guarantee. It does not affect specific legal rights of a consumer.

Daily care

The watch requires good daily care

- Do not wash the watch when its crown is at the extended position.
- Wipe away moisture, sweat or dirt with a soft cloth.
- After soaking the watch in seawater, be sure to wash the watch in clean pure water and wipe it dry carefully.

※ If your watch is rated as "non-water resistant" or "water resistant for daily use", do not wash the watch.

⇒ "CHECK THE CALIBER NUMBER AND WATER-RESISTANT LEVEL" page 3.

Turn the crown from time to time

- In order to prevent corrosion of the crown, turn the crown from time to time.
 - The same practice should be applied to a screw down crown.
- ⇒ "Crown" page 10.

Band

The band touches the skin directly and becomes dirty from sweat or dust. Therefore, lack of care may accelerate deterioration of the band or cause skin irritation or stain on the sleeve edge. The watch requires a lot of attention for long usage.

Metallic band

- Moisture, sweat or soil will cause rust even on a stainless steel band if they are left for a long time.
- Lack of care may cause a yellowish or gold stain on the lower sleeve edge of shirts.
- Wipe off moisture, sweat or soil with a soft cloth as soon as possible.
- To clean the soil around the joint gaps of the band, wipe it out in water and then brush it off with a soft toothbrush (Protect the watch body from water splashes by wrapping it up in plastic wrap etc.).
- Because some titanium bracelets use pins made of stainless steel, which has outstanding strength, rust may form in the stainless steel parts.
- If rust advances, pins may poke out or drop out, and the watch case may fall off the bracelet, or the clasp may not open.
- If a pin is poking out, personal injury may result. In such a case, refrain from using the watch and request repair.

Leather band

- A leather band is susceptible to discoloration and deterioration from moisture, sweat and direct sunlight.
- Wipe off moisture and sweat as soon as possible by gently blotting them up with a dry cloth.
- Do not expose the watch to direct sunlight for a long time.
- Please take care when wearing a watch with light-colored band, as dirt is likely to show up.
- Refrain from wearing a leather band watch other than Aqua Free bands while bathing, swimming, and when working with water even if the watch itself is water-resistant enforced for daily use.

Silicone band

- As for material characteristics, the band is easily dirtied, and may be stained and discolored. Wipe off dirt with a wet cloth or cleaning tissue.
- Unlike bands of other materials, cracks may result in the band being cut. Take care not to damage the band with an edged tool.

Notes on skin irritation and allergy

Skin irritation caused by a band has various reasons such as allergy to metals or leathers, or skin reactions against friction on dust or the band itself.

Notes on the length of the band

Adjust the band to allow a little clearance with your wrist to ensure proper airflow. When wearing the watch, leave enough room to insert a finger between the band and your wrist.



Magnetic resistance (Magnetic influence)

Affected by nearby magnetism, a watch may temporarily gain or lose time or stop operating.

Indication on the case back	Condition of use	Certified level
	Keep the watch more than 5 cm away from magnetic products.	4,800A/m
	Keep the watch more than 1 cm away from magnetic products.	16,000A/m
MAGNETIC RESISTANT 40000A/m	The watch can maintain its performance in most cases where it is brought close to (at least 1cm spaced from) magnetic products not only in normal daily life circumstances but also in a special work environment.	40,000A/m
MAGNETIC RESISTANT 80000A/m		80,000A/m

※ A/m (ampere meter) is the International unit (SI unit) for indicating the magnetic field.

Examples of common magnetic products that may affect watches

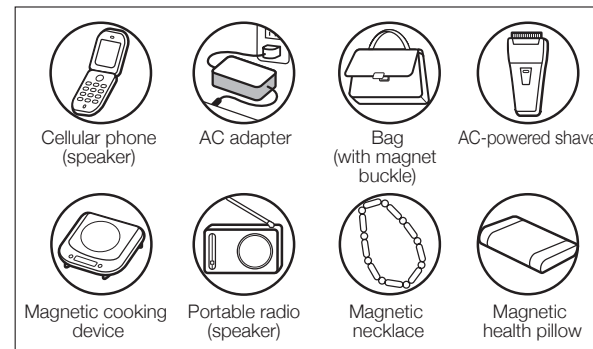

If the watch becomes magnetized and its accuracy deteriorates to an extent exceeding the specified rate under normal use, the watch may need to be demagnetized. In this case, you will be charged for demagnetization and accuracy readjustment even if it happens within the guarantee period.

The reason why analogue quartz watch is affected by magnetism

It is because the built-in motor of the watch, which harnesses magnetic power and external strong magnetism, affect each other to stop the motor or suppresses the turn of the motor.

Lumibrite

If your watch has Lumibrite

Lumibrite is a luminous paint that is completely harmless to human beings and the natural environment; containing no noxious materials such as radioactive substance. Lumibrite is a newly-developed luminous paint that absorbs light energy of the sunlight and lighting apparatus in a short time and stores it to emit light in the dark. For example, if exposed to a light of more than 500 lux for approximately 10 minutes, Lumibrite can emit light for 3 to 5 hours.

Please note, however, Lumibrite emits the light it stores, the luminance level of the light decreases gradually over time. The duration of the emitted light may also differ slightly depending on such factors as the brightness of the place where the watch is exposed to light and the distance from the light source to the watch.

※ In general, when you enter a dark place from a bright environment, your eye cannot adapt to the change in light levels quickly. At first, you can hardly see anything, but as time passes, your vision gradually improves. (Dark adaptation of the human eye)

Reference data on the luminance

Condition		Illumination
Sunlight	Fine weather	100,000 lux
	Cloudy weather	10,000 lux
Indoor (Window-side during daytime)	Fine weather	more than 3,000 lux
	Cloudy weather	1,000 to 3,000 lux
	Rainy weather	less than 1,000 lux
Lighting apparatus (40-watt daylight fluorescent light)	Distance to the watch: 1 m	1,000 lux
	Distance to the watch: 3 m	500 lux (average room luminance)
	Distance to the watch: 4 m	250 lux

Troubleshooting

Troubles	Possible Causes	Solutions
The watch stops operating.	The battery runs down.	Consult the retailer from whom the watch was purchased.
The watch temporarily gains/loses time.	The watch has been left in extremely high or low temperatures for a long time.	Normal accuracy will resume when the watch returns to normal temperature. Readjust the time.
	The watch was brought into close contact with a magnetic object.	By distancing magnetism, accuracy is recovered. Readjust the time. If accuracy is not recovered, consult the retailer from whom the watch was purchased.
	The watch was dropped, worn while playing active sports, hit against hard surfaces, or exposed to strong vibrations.	Readjust the time. If accuracy is not recovered, consult the retailer from whom the watch was purchased.
The seconds hand moves at two-second intervals.	The battery nears its end.	Consult the retailer from whom the watch was purchased.
The date changes during daytime.	A.m./p.m. is not correctly set.	Advance the hour hand for 12 hours and reset the time and date.
Blur in the display persists.	Small amount of water has got inside the watch due to deterioration of the gasket, etc.	Consult the retailer from whom the watch was purchased.

※ For the solution of troubles other than above, contact the retailer from whom the watch was purchased.

LEAP SECOND

Normally there are 86,400 seconds in a day. Due to a slight change in the earth's rotation, an extra second may be added to one day during the year. This is called the leap second. Every year the decision is made whether such an adjustment is needed. When the adjustment takes place, the standard time should be corrected by delaying the standard time one second. To keep your Grand Seiko watch accurate with the world standard time, adjust your watch to a time signal whenever such adjustment is made. According to the information from the observatories all over the world, the standard time is delayed one second simultaneously throughout the world by the Greenwich Royal Observatory. In the Greenwich Mean Time, an extra second will be added to the one minute between 11:59 p.m. and 0:00 a.m. either on December 31st or on June 30th. However, the adjustment may not be made in some years. Please check by a newspaper, etc. whether such an adjustment will be made or not.

SPECIFICATIONS (MOVEMENT)

Frequency of crystal oscillator	32,768 Hz (Hz = Hertz...Cycles per second)
Loss/gain (Annual rate)	±10 seconds when used on the wrist within a normal temperature range (between 5 °C and 35 °C) for approximately 8 hours per day. * Monthly rate of loss/gain may amount to approximately 2 seconds depending on the condition of use.
Operational temperature range	Between -10 °C and +60 °C
Driving system	Step motor
IC (Integrated Circuit)	C-MOS-IC: 1 piece

※ The specifications are subject to change without prior notice due to product improvement.

Caliber number	Battery (SB-)	Battery life
9F86	AN	Approximately 3 years
9F83		
9F82		
9F62		
9F61		
4J52	AG	Approximately 5 years
4J51	AC	
8J55	AN	Approximately 5 years

- The battery life is the estimated life for a watch with a new battery installed. The battery in your watch at the time of purchase was inserted in the watch at the factory for performance checks. It may run down earlier than the above-specified period.
- When the battery nears its end, the seconds hand moves at two-second intervals instead of normal one-second intervals. The watch remains accurate while the seconds hand is moving at two-second intervals.