

Thank you very much for choosing a SEIKO watch.  
For proper and safe use of your SEIKO watch,  
please read carefully the instructions in this  
booklet before using.

Keep this manual handy for easy reference.

\*Length adjustment service for metallic bands is available at the retailer from whom the watch was purchased or SEIKO CUSTOMER SERVICE CENTER.  
The service may also be available on a chargeable basis at other retailers, however, some retailers may not undertake the service.

## Contents

<b>1. About This Product</b>	About reception conditions	96
Handing cautions	Radio signal reception range : In Japan (JJY)	96
Features	Radio signal reception range : In China (BPC)	97
Display and button operation	Radio signal reception range: In the United States (WWVB)	98
How to use Button A and B	To enable the watch to easily receive a radio signal	99
Crown	Environments in which it is difficult to receive a radio signal	100
<b>2. Before Use</b>	How to check the reception status	102
Before use	How to display the reception result	102
Checking the charging status	<b>4. Time Zone Adjustment Function (Selecting transmitting station)</b>	
Checking the time and date	What is the time zone adjustment function?	104
<b>3. How to Set the Time and Date (Radio Signal Reception)</b>	Features of time zone adjustment function	104
Setting the time and date by receiving a radio signal	Questions and answers regarding time zone adjustment function	105
Mechanism of radio signal reception	How to set the time zone (Selecting transmitting station)	106
Automatic reception and manual reception	List of major time zones around the world	108

<b>5. Solar Charging Function</b>	Guarantee	132
About charging	After-sales service	134
How to charge the watch	<b>7. Troubleshooting</b>	
The indication time for charging the watch	How to conduct manual reception (Receiving a radio signal manually)	136
<b>About energy</b>	Conditions in which the watch may be unable to receive radio signals	138
Energy depletion forewarning function	How to manually set the time	138
Power save function	How to manually set the date	140
<b>6. To Preserve the Quality of Your Watch</b>	Preliminary position	142
To preserve the quality of your watch	Things around you which generate magnetism	143
Daily care	How to set the preliminary position	144
Performance and type	Setting the preliminary position of the date	144
Water resistance	Setting the preliminary positions of the hour and minute hands manually	146
Magnetic resistance	Troubleshooting	148
Band	In case of an abnormal movement	156
Special clasps	How to reset the Built-in IC system	156
Lumibrite	<b>8. Specifications</b>	
Power source	Specifications	162

## Handling cautions

### WARNING

To indicate the risks of serious consequences such as severe injuries unless the following safety regulations are strictly observed.

- Immediately stop wearing the watch in following cases.
  - If the watch body or band becomes edged by corrosion etc.
  - If the pins protrude from the band.
  - ※ Immediately consult the retailer from whom the watch was purchased or SEIKO CUSTOMER SERVICE CENTER.
- Keep the watch and accessories out of the reach of babies and children.
 

Care should be taken to prevent a baby or a child accidentally swallowing the accessories. If a baby or child swallows the battery or accessories, immediately consult a doctor, as it will be harmful to the health of the baby or child.

※ Immediately consult the retailer from whom the watch was purchased or SEIKO CUSTOMER SERVICE CENTER.

### CAUTIONS

To indicate the risks of light injuries or material damages unless the following safety regulations are strictly observed.

- Avoid the following places for wearing or keeping the watch.
  - Places where volatile agents (cosmetics such as polish remover, bug repellent, thinners etc.) are vaporizing
  - Places where the temperature drops below 5°C or rises above 35°C for a long time
  - Places affected by strong magnetism or static electricity
  - Places affected by strong vibrations
  - Places of high humidity
  - Dusty places
- If you observe any allergic symptoms or skin irritation
 

Stop wearing the watch immediately and consult a specialist such as a dermatologist or an allergist
- Other cautions
  - Do not disassemble or tamper with the watch.
  - Keep the watch out of the reach of babies and children.
  - Extra care should be taken to avoid risks of any injury or allergic rash or itching that may be caused when they touch the watch.

## Features

This solar-drive and radio-controlled watch is equipped with a radio signal adjustment function.

- The watch is operated by using "electric energy" which is converted from the light received by the solar panel.
- This watch displays the precise time by receiving radio signals conveying time information. It can receive official standard frequencies from Japan (from either of two transmitting stations), the People's Republic of China, and the United States of America.

- Radio Signal Receiving Function ..... This watch adjusts the time and the date precisely by automatically receiving radio signals daily. In addition, radio signals can be forcibly received with manual operation. This watch can receive official standard radio signals from Japan (from 2 transmitting stations), China, and the United States (the transmitting station for receiving radio signals can be selected using the time zone adjustment function).
- Display Function of Radio Signal Reception Level ..... The movement of the second hand indicates the radio signal reception level during radio signal reception attempts.
- Display Function of Radio Signal Reception Results ..... The movement of the second hand indicates radio signal reception results (Yes/No).

- Time Zone Adjustment Function... (Selecting Transmitting Station) → pages 104 - 109

- Solar Charging Function... → pages 110 - 111

- Energy Depletion Forewarning Function... → page 112
- Power Save Function... → page 113

- Automatic Hand Position Alignment Function... → page 142

This watch can display local time around the world by setting the appropriate time zone. In addition, setting the time zone enables the watch to receive official standard radio signals to set the time if the watch is worn in a radio signal reception range.

A solar cell underneath the dial converts any form of light into electrical energy to charge it. Once fully charged, the watch continues to run for approximately six months.

The movement of the second hand indicates that the battery should be charged. This watch is equipped with a function which can suppress energy consumption when it is left without receiving an adequate light source for a certain length of time.

When the hand positions display an incorrect time as a result of external influences such as magnetism, the watch automatically corrects the hand misalignment.

## Display and button operation

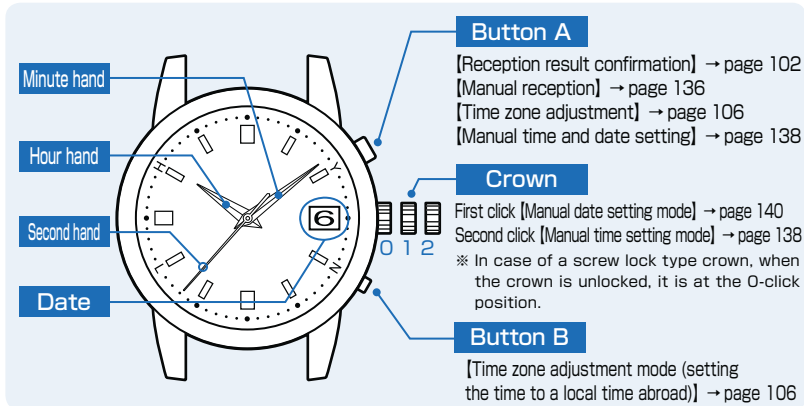

### Button A

[Reception result confirmation] → page 102  
 [Manual reception] → page 136  
 [Time zone adjustment] → page 106  
 [Manual time and date setting] → page 138

### Crown

First click [Manual date setting mode] → page 140  
 Second click [Manual time setting mode] → page 138  
 ※ In case of a screw lock type crown, when the crown is unlocked, it is at the O-click position.

### Button B

[Time zone adjustment mode (setting the time to a local time abroad)] → page 106

## Reception Level Display

### [manual reception]

H ··· High reception level (50second position)  
 L ··· Low reception level (40second position)  
 N ··· Unable to receive radio signals (20second position)

※ "About the reception level display" refer to page 137

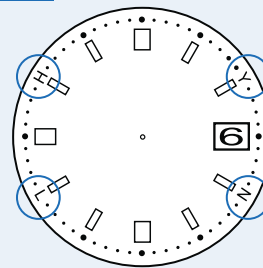

## Reception Result Display

### [Confirmation of reception result]

Y ··· Reception Successful (10second position)  
 N ··· Reception Failed (20second position)

※ "Confirm reception result" refer to page 102

※ Positions of above displays may differ depending on the model.

## How to use Button A and B

Buttons A and B are recessed in the watchcase to improve the design and to prevent erroneous operation. Please refer to the following figures for how to press the buttons.

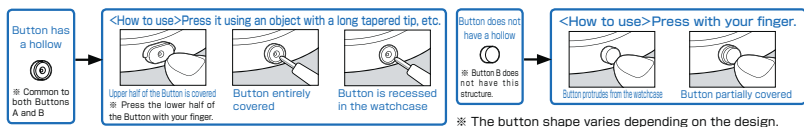

### ■ When pressing Buttons A and B at the same time

Make sure to confirm "How to use Buttons A and B" as shown above before pressing the buttons. First, press Button B, and press Button A while pressing Button B so as to press them successfully.

### • Both Buttons A and B have a hollow

Press the buttons using an object with a long tapered tip holding the watch as shown in the figure so that the watch does not move.

### • Button A does not have a hollow, and Button B has a hollow

Press Button A with your finger and Button B using an object with a long tapered tip.



※ Press the buttons on a soft cloth or the like before operation in order to prevent damage to the watch.

## Crown

There are two types of crowns, a normal crown and a screw-lock crown. Check the crown on your watch.

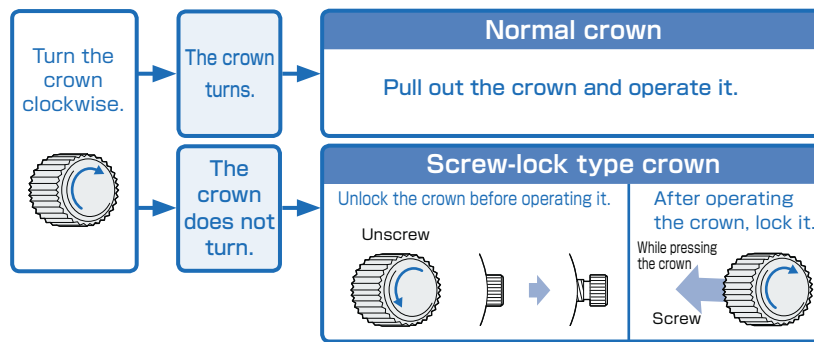

※ If your watch has a screw-lock crown, the crown screws into the watch to prevent malfunction and increase water resistance.  
 ※ Be careful not to screw the crown in by force as it may damage the slots of the crown.

## Before use

### ① Checking the charging status

When the movement of the second hand shows an energy depletion state, the battery requires charging.

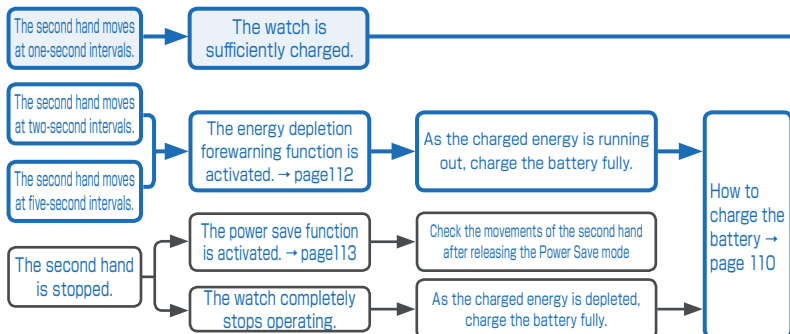

※ If the second hand does not move at one-second intervals even after fully charging the battery → At Trouble on page 150

### ② Checking the time and date

※ The hands of this watch cannot be moved by turning the crown. So when adjusting the time, refer to the following pages regarding the procedures.

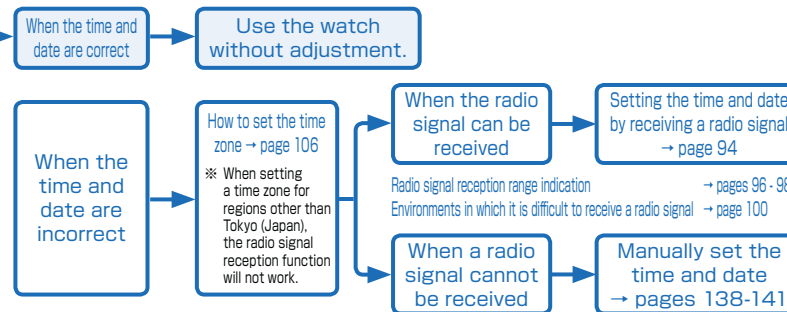

※ When the watch is not displaying the precise time and date even after successfully receiving a radio signal → In this case, refer to Misalignment of the time and hands on page 152 and Misalignment of the date on page 154.

## Setting the time and date by receiving a radio signal

### ■ Mechanism of radio signal reception

The radio-controlled watch displays the precise time and date by automatically receiving and synchronizing itself with the radio signal of an official standard frequency.

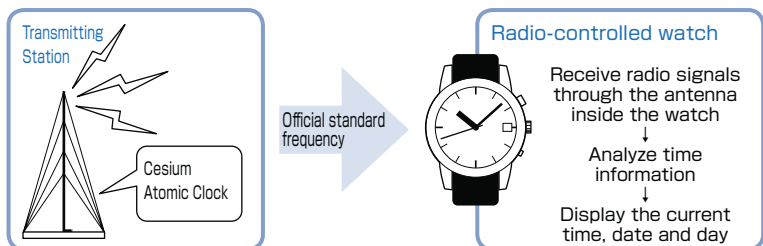

Time signal transmitted by a standard frequency is based on a super accurate "Cesium Atomic Clock" that may have a 1 second loss or gain per one hundred thousand years.

## Automatic reception and manual reception

This watch sets the time and date by automatically receiving a radio signal at a fixed time.

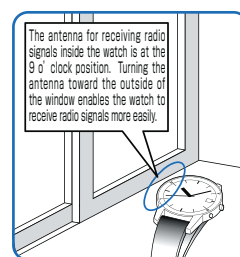

### • Automatic reception

This watch automatically receives a radio signal at 2:00 AM.  
 ※ If the watch fails to receive a radio signal at 2:00 AM, it will attempt to receive a radio signal at 3:00 AM. If it fails again, it will attempt to receive a radio signal at 4:00 AM.

When receiving radio signals, place the watch in a place where it can easily receive a radio signal.

### • Manual reception

When this watch cannot automatically receive a radio signal due to a difficult receiving environment, it is possible to receive them arbitrarily at any time. How to conduct manual reception → pages 136-137

※ When setting a time zone for regions other than radio signal reception range, the radio signal reception function will not work.  
 Check the setting of the time zone → How to set the time zone (Selecting transmitting station) on pages 106-107  
 ※ Radio signal reception results depend on a receiving condition. → Environments in which it is difficult to receive a radio signal on page 100  
 ※ This watch is unable to receive radio signals outside a reception range → Radio signal reception range indication on pages 96-98  
 ※ When the watch is not displaying the precise time and date even after successfully receiving a radio signal → At Trouble: Misalignment of the time and hands on page 152, Misalignment of the date on page 154.

## About reception conditions

### Radio signal reception range: In Japan (JJY)

The reception range from each transmitting station is approximately 1,000 km (1,000 km radius of each station).

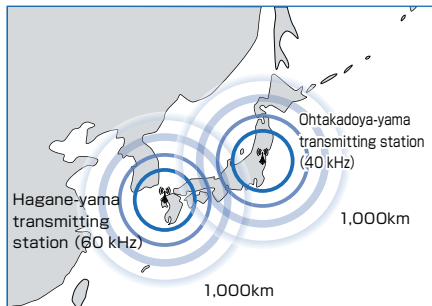

JJY is operated by the National Institute of Information and Communications Technology (NICT). JJY is transmitted from two stations in Japan. Each station transmits JJY in a different frequency. Fukushima (Ohtakadoya-yama transmitting station: 40 KHz) Kyushu (Hagane-yama transmitting station: 60 KHz)

- ※ NICT: National Institute of Information and Communications Technology
- ※ Whether the watch succeeds in receiving radio signals or not depends on the receiving conditions. Refer to "Environments in which it is difficult to receive a radio signal" on page 100.

### Radio signal reception range: In China (BPC)

The reception range from the transmitting station is approximately 1,500 km (1,500 km radius of the transmitting station).

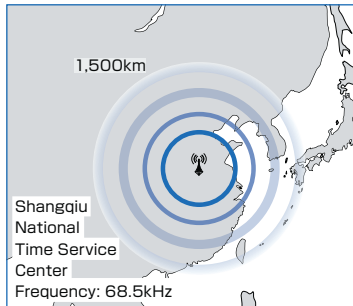

BPC is operated by NTSC. Shangqiu National Time Service Center Frequency: 68.5kHz

※ NTSC: National Time Service Center

- ※ The watch may be able to receive radio signals outside a reception range if the receiving conditions are favorable.
- ※ The watch may fail to receive radio signals depending on the reception conditions (weather, geographic locations, radio disturbances such as tall buildings, and orientation of the watch). Environments in which it is difficult to receive a radio signal on page 100.

### Radio signal reception range: In the United States (WWVB)

The reception range from the transmitting station is approximately 1,500 km (1,500 km radius of Fort Collins radio station). There are four time zones within the reception range.

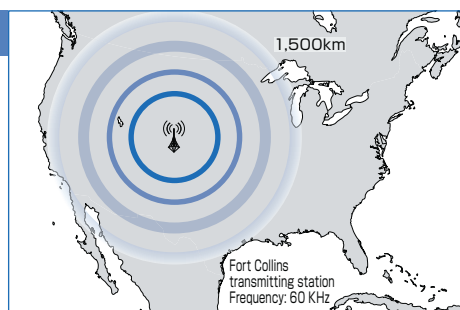

WWVB is operated by NIST.

Fort Collins transmitting station Frequency: 60 KHz

※ NIST: National Institute of Standards and Technology

- ※ The watch may be able to receive radio signals outside a reception range if the receiving conditions are favorable.
- ※ The watch may fail to receive radio signals depending on the reception conditions (weather, geographic locations, radio disturbances such as tall buildings, and orientation of the watch). Environments in which it is difficult to receive a radio signal on page 100.

### To enable the watch to easily receive a radio signal

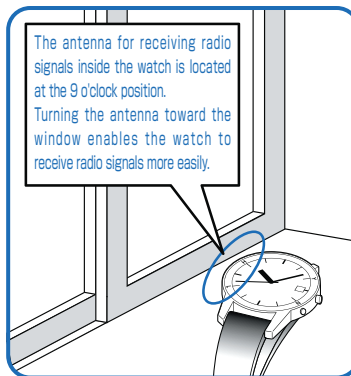

Place the watch where it can receive radio signals more easily, such as by the window.

In order to secure a stable radio signal reception, keep the watch stationary without changing the direction of the watch or tilting it during radio signal reception.

### Environments in which it is difficult to receive a radio signal

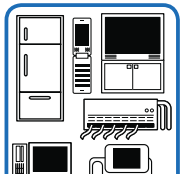

- Close to home electrical appliances such as TV's, refrigerators or air conditioners
- Close to OA devices such as mobile phones, personal computers or fax machines
- Close to steel desks or other furniture made of metal



- In places generating radio interference, such as construction sites or places with heavy traffic.

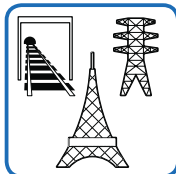

- Close to overhead power lines, TV stations, train cables.

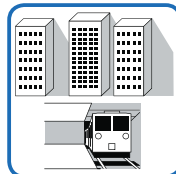

- Inside a building, between tall buildings, underground.



- Inside a vehicle, train, or airplane

Avoid putting the watch in such places when it receives radio signals.

### NOTICE

- The watch may display the wrong time if it fails to receive radio signals properly because of interference. The watch may also fail to receive radio signals properly depending on the location or radio wave receiving conditions. In this case, move the watch to another place where it can receive radio signals.
- When the watch is out of reception range, its accurate quartz movement will continue to keep the time.
- The time signal transmission may be stopped during maintenance of the facilities of each transmitting station or because of a lightning strike. In such a case, see each station's website for further information or contact SEIKO CUSTOMER SERVICE CENTER.
- Websites of transmitting stations (as of November, 2007)  
Japan: NICT (Japan Standard Time Group) <http://www.jjy.nict.go.jp/>  
China: NTSC <http://www.ntsc.ac.cn>  
The United States of America: NIST <http://www.boulder.nist.gov/timefreq/stations/wwvb.htm>
- SEIKO CUSTOMER SERVICE CENTER: 0120-612-911 (toll free in Japan)

## How to check the reception status

### How to display the reception results

This watch displays the latest reception results (Yes/No) of a radio signal for five seconds.

① Press Button A once and then release it.

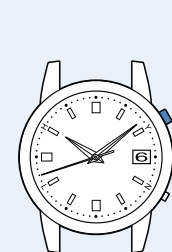

Press Button A once and then release it.

- ※ How to use button A and B → page 90
- ※ When Button A is kept pressed for three seconds or longer, the second hand starts to move to the "Zero Second Position," and then the watch switches to the Manual Reception Mode. In this case, press Button A again to display the time.

② The second hand indicates the reception results.

If a reception was successful: The second hand points to Y (Yes; the 10 second position)

If a reception has failed: The second hand points to N (No; the 20 second position)

※ If Button A is pressed after five seconds or while the second hand is moving to display the reception results, the reception results display function is cancelled and the second hand resumes its normal movement.

### If a reception was successful: The second hand points to Y

- A radio signal has been received successfully. Use the watch without any adjustments.  
※ When the watch is not displaying the precise time and date even after successfully receiving a radio signal → In this case, refer to Misalignment of the time and hands on page 152 and Misalignment of the date on page 154.

### If reception has failed: The second hand points to N.

- Place the watch in a place where it can easily receive a radio signal, or change its direction. Even within the radio signal reception range, this watch may fail to receive a radio signal depending on the condition (due to the influence of weather, geographical features, buildings, or direction). → In this case, refer to Environments in which it is difficult to receive a radio signal on page 100. This watch is unable to receive radio signals outside a reception range → Radio signal reception range indication on pages 96 - 98
- Attempt to receive a Radio Signal in a different time period (In the case of manual reception). Receiving environments differ according to time periods even at the same place. Due to radio signal characteristics, the watch is able to easily receive radio signals during nighttime hours.
- When manually adjusting the time even after successfully receiving a radio signal, reception results are reset to "N."  
※ When pulling the crown to the second click, the watch enters the manual time setting mode, and resets the reception results without adjusting the time.
- When the watch is unable to receive radio signals, it may move depending on the quartz movement.  
※ Accuracy of loss / gain: ± 15 seconds per month

# What is the time zone adjustment function?

## Features of time zone adjustment function

- This watch is able to be set to an overseas local time in one-hour units. Most of the regions around the world adopt time differences based on one-hour units. The watch set time difference based on UTC (Coordinated Universal Time). The range of time differences around the world centered from UTC is "from - 11 hours to + 13 hours."
  - This watch can automatically display the local time of a desired area by selecting its time zone. When the watch is set in the time zone adjustment mode, the second hand indicates the time zone. Press the button to set the time zone referring to the position of the second hand.
  - This watch selects a radio signal transmitting station by setting the time zone. When the watch is used in Tokyo, set the second hand to "Tokyo (Japan): 9 second position" to receive the official standard frequency of Japan. When the watch is used in China, set the second hand to "Hong Kong (China): 8 second position" to receive the official standard frequency of Japan. If a time zone other than a radio signal reception range is selected, the radio signal reception function will not work.
- How to set the time zone pages 106-107  
→ List of major time zones around the world page 108

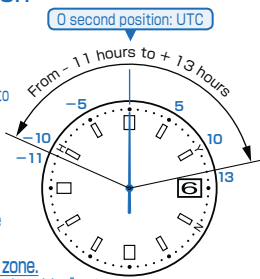

## Questions and answers regarding time zone adjustment function

- Q: When returning to Japan from overseas, is the time automatically set to Japan time?  
A: Just moving cannot adjust the time to Japan time. After setting the time difference, radio signal reception is not performed. When wearing a watch in Japan, set to Japan time by use of the time zone adjustment function.
- Q: The hands stop during operation of time zone setting, therefore, does time lag occur?  
A: The internal circuit stores the time, therefore, no time lag occurs.
- Q: How accurate is the watch while the time difference is being set.  
A: While the time zone is being set, the watch has an accuracy of a normal quartz watch. (Monthly rate: ± 15 seconds)
- Q: How is adjustment made to a local time with a time difference of 15 minutes or 30 minutes?  
A: The time can be adjusted on a 1 hour basis by use of the time zone adjustment function. When adjusting to a local time with a time zone difference of 15 minutes or 30 minutes, please refer to the "How to manually set the time" on pages 138-139.

## How to set the time zone (Selecting transmitting station)

### 1 Press and hold Button B until the second hand moves (for four seconds).

The second hand starts to move, and then the watch enters the time zone adjustment mode.

When a no movement state of the second hand is kept for ten seconds or more, the watch automatically switches to the time display state. When it is in the middle of operation, re-attempt the operation from procedure "1."

※ Press Button B with a pointed object.  
→ page 90  
※ How to use button A and B → page 90

Press and hold Button B for four seconds.

### 2 Set the Time Zone by pressing the button to move the second hand.

The radio signal transmitting station can be changed by setting the time zones. When setting a time zone for regions other than reception range, the radio signal reception function will not work.

Set the time zone by moving the second hand. The one-second movement of the second hand is equivalent to one hour in the time zone.

The second hand moves clockwise by pressing Button A.  
Pressing the button once moves the second hand every one second.  
The second hand moves counterclockwise by pressing Button B.

※ The buttons can be pressed continuously.

### 3 The watch automatically terminates the mode.

When the no movement state of the minute and hour hands is kept for ten seconds, the watch automatically terminates the Time zone adjustment mode.

In the case that the date changes, the date display changes afterward.

※ During movement of the date, neither the buttons nor the crown can be operated.

## List of major time zones around the world

When setting a time zone for a region where no receivable official standard frequency is mentioned in the table below, the radio signal reception function will not work.

Position that the second hand indicates	Time difference with UTC	Name of representative city (Time zone)	Receivable official standard frequency
0-second position	± 0 hour	London/UTC ★	-
1-second position	+1 hours	Paris/Berlin ★	-
2-second position	+2 hours	Cairo ★	-
3-second position	+3 hours	Jeddah	-
4-second position	+4 hours	Dubai	-
5-second position	+5 hours	Karachi	-
6-second position	+6 hours	Dhaka	-
7-second position	+7 hours	Bangkok	-
8-second position	+8 hours	Hong Kong (China) BPC	-
9-second position	+9 hours	Tokyo (Japan) JJY	-
10-second position	+10 hours	Sydney ★ JJY △	-
11-second position	+11 hours	Nouméa	-
12-second position	+12 hours	Wellington ★	-
13-second position	+13 hours	(DST Wellington)	-

Position that the second hand indicates	Time difference with UTC	Name of representative city (Time zone)	Receivable official standard frequency
0-second position	± 0	London/UTC ★	-
59-second position	-1 hours	Azores ★	-
58-second position	-2 hours	(DST Rio de Janeiro)	-
57-second position	-3 hours	Rio de Janeiro ★	-
56-second position	-4 hours	Santiago ★	WWVB △
55-second position	-5 hours	New York ★	WWVB
54-second position	-6 hours	Chicago ★	WWVB
53-second position	-7 hours	Denver ★	WWVB
52-second position	-8 hours	Los Angeles ★	WWVB
51-second position	-9 hours	Anchorage ★	-
50-second position	-10 hours	Honolulu	-
49-second position	-11 hours	Midway Islands	-

Daylight Saving Time (Summer Time) is in effect in time zones indicated with a "★" mark.  
(As of November 2007)

If a receivable official standard frequency is indicated with a "△" mark, summer time in the time zone can be set by receiving the frequency if the time zone is within the radio signal reception range.

There are time differences around the world based on "Coordinated Universal Time (UTC)." There are 24 regions (Time Zones) around the world with a time difference of one hour. This system has been adopted internationally by setting the total time difference around the world as 24 hours. In addition, Daylight Saving Time (Summer Time) is individually adopted in some regions.

**[What is UTC (Coordinated Universal Time)?]**  
UTC is the universal standard time coordinated through international agreement. It is used as the official time around the world. UTC is determined by adding a leap second to GMT (Greenwich Mean Time), which is determined through astronomical measurement, in order to keep the precise time.

**[What is summer time (DST)?]**  
Summer time is daylight saving time. Advancing the watch one hour to prolong daytime during longer daylight hours in summer. Daylight saving time has been adopted in about 80 countries, mainly in Europe and North America. The adoption and duration of daylight saving time vary depending on the country.

- ※ Time differences between regions and daylight saving time may change due to circumstances of a country or region.
- ※ A time difference established in 15 minute or 30 minute units is adopted in very limited regions (ex. India).
- ※ Each indication may differ depending on the model (design) of the watch. (As of April 2014)

## About charging

### How to charge the watch

To enjoy optimal performance of this watch, make sure that the watch is kept sufficiently charged at all times.

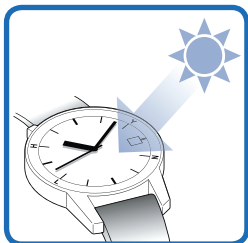

To charge the watch, expose the dial (solar cell) to adequate light.

- ※ When changing the watch, keep the watch temperature under 60°C
- ※ Before initially using the watch or when the watch has stopped as a result of complete depletion of stored power, charge the watch sufficiently.

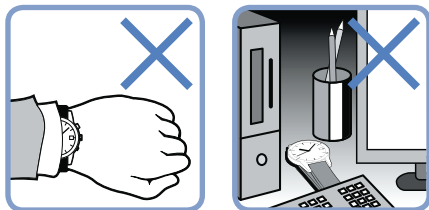

If the watch is concealed under a long sleeve shirt, or if it is used or stored continually under conditions where it cannot receive sufficient light, the power stored in the solar cell may be easily depleted because the watch cannot be sufficiently charged.

### The indication time for charging the watch

#### Standard charging time

Illumination (LUX)	Light source	Condition (Example)	Time required for fully charging the watch	Time required for charging the watch to start moving at one-second intervals ★	Time required for charging the watch to run for one day
500	Incandescent light	60W 60cm	-	-	5 hours
700	Fluorescent light	General offices	-	-	3 hours
1,000	Fluorescent light	30W 70cm	-	120 hours	2 hours
3,000	Fluorescent light	30W 20cm	90 hours	30 hours	30 minutes
5,000	Fluorescent light	30W 12cm	70 hours	24 hours	24 minutes
10,000	Fluorescent light	30W 5cm	25 hours	8 hours	9 minutes
10,000	Sunlight	Cloudy day	25 hours	8 hours	9 minutes
100,000	Sunlight	Sunny day (Under the direct sunlight on a summer day)	8 hours	2 hours	3 minutes

- ★ The figures in the table above refer to the time required to charge the stopped watch by exposure to light until the watch moves at steady one-second intervals. Even if the watch is partially charged for a period shorter than the time provided in the above table, it will resume one-second interval movement, however, the one-second interval movement will change to two-second interval movement shortly. To avoid this and charge the watch to a sufficient level, use the charging time mentioned above as a measure.
- ※ The required charging time slightly varies depending on the model of the watch.
- ※ The movement of the second hand checking the charging status → page 92

## About energy

### Energy depletion forewarning function

The energy depletion forewarning function is activated when the energy stored in the watch runs low. In such a case, the second hand moves at two-second intervals. If the watch continues to be in the state of two-second interval movement, the watch switches to five-second interval movement, followed by a completely stopped state. If the energy depletion forewarning function is activated, charge the watch sufficiently.

How to charge the watch... page 110

Standard charging time .....page 111

- ※ Neither the buttons nor the crown can be operated while the second hand moves at two-second or five-second intervals (this is not a malfunction) .
- ※ While the second hand moves at five-second intervals, the hour and minute hands, date and day stop operating.
- ※ While the second hand moves at five-second intervals, the watch is unable to receive radio signals automatically. After the watch is charged sufficiently and the second hand returns to normal one-second interval movement, conduct the manual reception of radio signals to set the watch to the correct time. (Refer to "How to set the time, date and day" on page 95.)

112

### Power save function

This watch is equipped with a power save function (Power Saving) which can suppress energy consumption when it is left without receiving an adequate light source for a certain length of time.

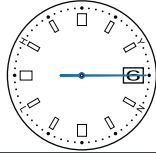
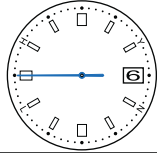
	Power Save 1	Power Save 2
Condition	When the watch is exposed to a state without receiving an adequate light source for 72 hours or longer.	When the watch is in an insufficient charging state for a long time.
Situation	 The second hand stops pointing at the 15-second position, and the hour and minute hands also stop.	 The second hand stops pointing at the 45-second position, and the hour and minute hands also stop. The watch does not conduct automatic radio signal receiving.
How to handle the situation	When the watch is exposed to an adequate light source for five seconds or longer, it displays the current time again after the second hand is rapidly advanced.	After sufficiently charging the battery, set the watch for the current time, if necessary.

#### Power Save 2

- ※ While the watch is being charged, the second hand moves at "Five-second Intervals."
- ※ During the "Five-second Interval Movement," neither the buttons nor the crown can be operated.
- ※ If the "Power Save 2" mode is prolonged, the stored power amount drops and the internal current time information stored will be lost. When the watch returns to its normal movement of one-second interval after sufficiently charging the battery, set the current time by receiving a radio signal. (Refer to Setting the time and date by receiving a radio signal → page 95)

113

## To preserve the quality of your watch

### Daily care

#### The watch requires good daily care

- Wipe away moisture, sweat or dirt with a soft cloth
- To clean the clearances (around the metallic band, crown or case back), a soft toothbrush is convenient.
- After soaking the watch in seawater, be sure to wash the watch in clean pure water and wipe it dry carefully.

#### Turn the crown from time to time

- In order to prevent corrosion of the crown, turn the crown from time to time.
- The same practice should be applied to a screw lock type crown. (No need to pull out the screw lock type crown.)  
Crown → page 91

114

### Performance and type

The case back shows the caliber and performance of your watch

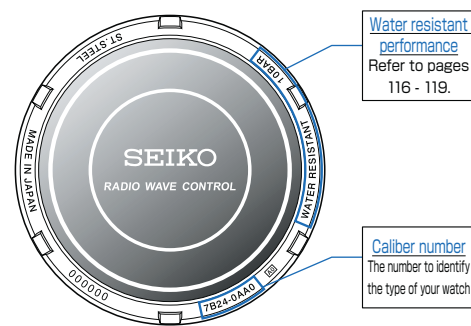

※ The figure above is one example. Performance of your watch is different from above sample.

115

### Water resistance

Refer the table below for the description of each degree of water resistant performance of your watch before using.  
(Refer to " page 115 ")

Indication on the case back	Water resistant performance	Condition of use
No indication	Non-water resistance	Avoid drops of water or sweat
WATER RESISTANT	Water resistance for everyday life	The watch withstands accidental contact with water in everyday life. <b>WARNING</b> Not suitable for swimming
WATER RESISTANT 5 BAR	Water resistance for everyday life at 5 barometric pressures	The watch is suitable for sports such as swimming.
WATER RESISTANT 10 (20) BAR	Water resistance for everyday life at 10(20) barometric pressures.	The watch is suitable for diving not using an air cylinder.

116

117

#### WARNING



**Do not use the watch in scuba diving or saturation diving.**

The various tightened inspections under simulated harsh environment, which are usually required for watches designed for scuba diving or saturation diving, have not been conducted on the water-resistant watch with the BAR (barometric pressure) display. For diving, use special watches for diving.

#### CAUTION

- ※ If the inner surface of the glass is clouded with condensation or water droplets appear inside of the watch for a long time, the water resistant performance of the watch is deteriorated. Immediately consult the retailer from whom the watch was purchased or SEIKO CUSTOMER SERVICE CENTER (listed on the end of a book).



**Do not turn or pull out the crown when the watch is wet.**

Water may get inside of the watch.

118

#### CAUTION



**Do not leave moisture, sweat and dirt on the watch for a long time.**

Be aware of a risk that a water resistant watch may lessen its water resistant performance because of deterioration of the adhesive on the glass or gasket, or the development of rust on stainless steel.



**Do not wear the watch while taking a bath or a sauna.**

Steam, soap or some components of a hot spring may accelerate the deterioration of water resistant performance of the watch.





**Do not pour running water directly from faucet.**

The water pressure of tap water from a faucet is high enough to degrade the water resistant performance of a water resistant watch for everyday life.

119

## Magnetic resistance

Affected by nearby magnetism, a quartz watch may temporarily gain or lose time or stop operating.  
 ※When the hand positions deviate to display incorrect time as a result of influence of magnetism, this watch automatically corrects the hand alignment itself. (Refer to page 142)

Indication on the case back	Condition of use
No indication	Keep the watch more than 10 cm away from magnetic products.
	Keep the watch more than 5 cm away from magnetic products. (JIS level-1 standard)
	Keep the watch more than 1 cm away from magnetic products. (JIS level-2 standard)

## Band

The band touches the skin directly and becomes dirty with sweat or dust. Therefore, lack of care may accelerate deterioration of the band or cause skin irritation or stain on the sleeve edge. The watch requires a lot of attention for long usage.

### • Metallic band

- Moisture, sweat or soil will cause rust even on a stainless steel band if they are left for a long time.
- Lack of care may cause a yellowish or gold stain on the lower sleeve edge of shirts.
- Wipe off moisture, sweat or soil with a soft cloth as soon as possible
- To clean the soil around the joint gaps of the band, wipe it out in water and then brush it off with a soft toothbrush. (Protect the watch body from water splashes by wrapping it up in plastic wrap etc.)
- Because some titan bracelets use pins made of stainless steel, which has outstanding strength, rust may form in the stainless steel parts.
- If rust advances, pins may poke out or drop out, and the watch case may fall off the bracelet, or the clasp may not open.
- If a pin is poking out, personal injury may result. In such a case, refrain from using the watch and request repair.

## Special Clasps

There are 3 type of special clasps as described below; If the clasp of the watch you purchased is one of them, please refer to the indications.

**A A Type** → page 125

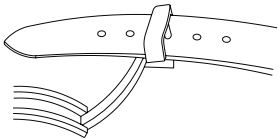

**B B Type**  
→ page 126

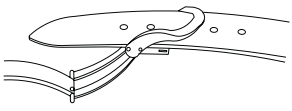

**C C Type** → page 128

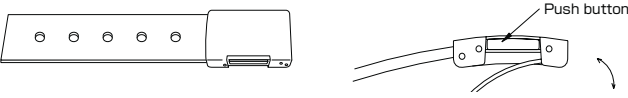

## B B Type

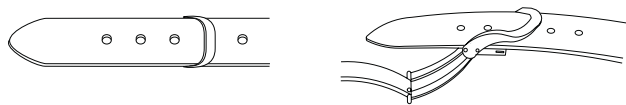

### • How to wear or take off the watch

- Press the button on both sides of the buckle ; pull the buckle up. The band will automatically come out of the loop.
- Place the tip of the band into the moveable loop and fixed loop, and fasten the clasp by pressing the frame of the buckle.

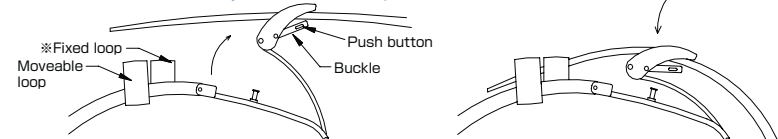

※ No Fixed loop with Metal Bracelets.

## Examples of common magnetic products that may affect watches

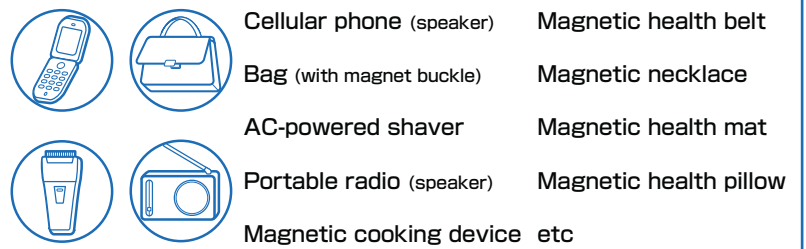

The reason why analogue quartz watch is affected by magnetism.

It is because the built-in motor of the watch, which harnesses magnetic power and external strong magnetism, affect each other to stop the motor or suppresses the turn of the motor.

### • Leather band

- A leather band is susceptible to discoloration and deterioration from moisture, sweat and direct sunlight.
- Wipe off moisture and sweat as soon as possible by gently blotting them up with a dry cloth.
- Do not expose the watch to direct sunlight for a long time.
- Please take care when wearing a watch with light-colored band, as dirt is likely to show up.
- Refrain from wearing a leather band watch other than Aqua Free bands while bathing, swimming, and when working with water even if the watch itself is water-resistant enforced for daily use (10-BAR water resistant).

### • Polyurethane band

- A polyurethane band is susceptible to discoloration from light, and may be deteriorated by solvent or atmospheric humidity.
- Especially a translucent, white, or pale colored band easily adsorbs other colors, resulting in color smears or discoloration.
- Wash out dirt in water and clean it off with a dry cloth. (Protect the watch body from water splashes by wrapping it up in plastic wrap etc.)
- When the band becomes less flexible or cracked, replace the band with a new one.

Notes on skin irritation and allergy	Skin irritation caused by a band has various reasons such as allergy to metals or leathers, or skin reactions against friction on dust or the band itself.
Notes on the length of the band	Adjust the band to allow a little clearance with your wrist to ensure proper airflow. When wearing the watch, leave enough room to insert a finger between the band and your wrist. 

## A A Type

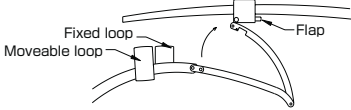
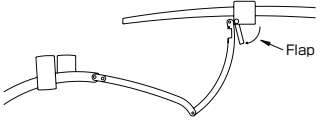
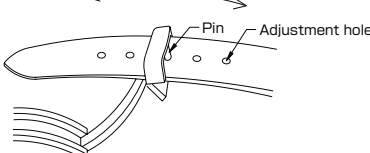
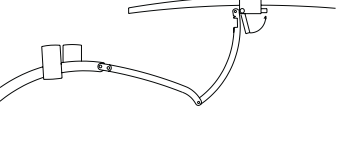
- Lift up the clasp to release the buckle. 
- Open the flap. 
- Take the pin out of the adjustment hole, adjust the size of the strap by sliding it back and forth, and then put the pin back into the appropriate adjustment hole. 
- Close the flap. 

### • How to adjust the length of the leather band

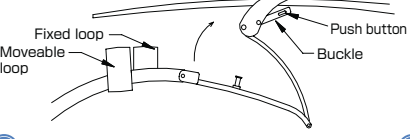
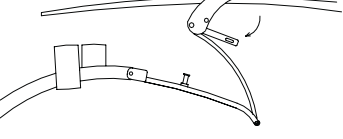
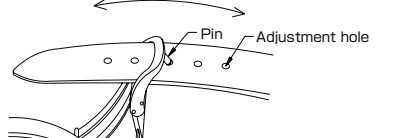
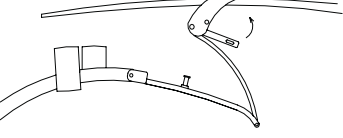
- With pressing buttons on both sides of the buckle, pull the leather band out of the moveable loop and fixed loop. Then open the clasp. 
- Press the push buttons again to unfasten the buckle. 
- Pull the pin out of a adjustment hole of the band. Slide the band to adjust its length and find an appropriate hole. Place the pin into the hole. 
- Fasten the buckle with pressing the push buttons. 

## C C Type

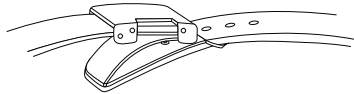
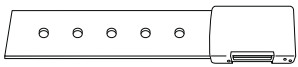

- ① Press the button on the buckle, and lift to open the clasp.

- ② To adjust : Pull the pins out of the adjustment holes on the band. Slide the band to the appropriate length. Push the pins into the new holes on the band.

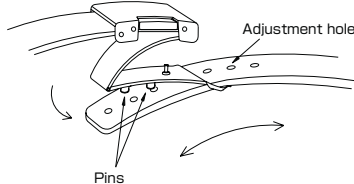
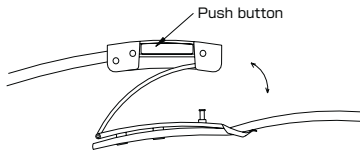

128

## Lumibrite

### If your watch has Lumibrite

Lumibrite is a luminous paint that is completely harmless to human beings and natural environment, containing no noxious materials such as radioactive substance. Lumibrite is a newly-developed luminous paint that absorbs the light energy of the sunlight and lighting apparatus in a short time and stores it to emit light in the dark. For example, if exposed to a light of more than 500 lux for approximately 10 minutes, LumiBrite can emit light for 3 to 5 hours. Please note, however, that, as LumiBrite emits the light it stores, the luminance level of the light decreases gradually over time. The duration of the emitted light may also differ slightly depending on such factors as the brightness of the place where the watch is exposed to light and the distance from the light source to the watch.

Condition		Illumination
Sunlight	Fine weather	100,000 lux
	Cloudy weather	10,000 lux
Indoor (Window-side during daytime)	Fine weather	more than 3,000 lux
	Cloudy weather	1,000 to 3,000 lux
	Rainy weather	less than 1,000 lux
Lighting apparatus (40-watt daylight fluorescent light)	Distance to the watch: 1 m	1,000 lux
	Distance to the watch: 3 m	500 lux (average room luminance)
	Distance to the watch: 4 m	250 lux

129

## Power source

### • Overcharge prevention function

When the secondary battery is fully charged, the overcharge prevention function is automatically activated to avoid further charging. There is no need to worry about damage caused by overcharging no matter how much the secondary battery is charged in excess of the "time required for fully charging the watch".

※ Refer to "Standard charging time" on page 111 to check the time required for fully charging the watch.

#### NOTICE

##### (Notes on charging the watch)

- When charging the watch, do not place the watch in close proximity to an intense light source such as lighting equipment for photography, spotlights or incandescent lights, as the watch may be excessively heated resulting in damage to its internal parts.
- When charging the watch by exposure to direct sunlight, avoid places that easily reach high temperatures, such as a car dashboard.
- Always keep the watch temperature under 60°C.

130

### • Power source

The battery used in this watch is a special secondary battery, which is different from ordinary batteries. Unlike an ordinary silver oxide battery, the secondary battery does not require periodic replacement. However, if the secondary battery is charged or discharged repeatedly over an extended period of time, its life may shorten. (This condition changes depending upon usage condition and storage environment.)

The secondary battery is an environmentally friendly, clean energy storage device.

#### NOTICE

- When replacing the secondary battery, make sure that the exclusive secondary battery for this watch is used. Installation of an ordinary silver oxide battery can generate heat that can cause bursting or ignition.
- Even when a silver oxide battery is substituted, electrical continuity cannot be obtained.

131

## Guarantee

Within one year from the date of purchase, we guarantee free repair/adjustment service against any defects according to the following guarantee regulations, provided that the watch was properly used as directed in this instruction booklet.

### • Guarantee coverage

The watch body (movement-case) and metallic band.

### • Exceptions from guarantee

In following cases, repair/adjustment services will be at cost even within the guarantee period or under guarantee coverage.

- Change of leather/urethane/cloth band
- Troubles or damage caused by accidents or improper usage
- Scratches or grime caused by use
- Problems and damage caused by acts of god, natural disasters including fire, floods or earthquakes.
- The certificate of guarantee is valid only if all the necessary items are properly filled in. We will not honor an altered or tampered certificate of guarantee for free repair services.

132

Free repair services are guaranteed only under the period and conditions specified in the certificate of guarantee. It does not affect specific legal rights of a consumer. The certificate of guarantee is valid only in Japan.

### • Procedure to claim free repair services

- For any defects under guarantee, submit the watch together with the attached certificate of guarantee to the retailer from whom the watch was purchased.
- If repair services cannot be provided by the retailer from whom the watch was purchased, contact SEIKO CUSTOMER SERVICE CENTER. In this case, the attached certificate of guarantee is also needed.

### • Others

- The movements, case, dial, hands, glass, crown, button and bracelet, or parts thereof may be repaired with substitutes whose outward appearance may differ from the originals. If necessary, movements will be replaced.
- For length adjustment service of a metallic band, ask the retailer from whom the watch was purchased or SEIKO CUSTOMER SERVICE CENTER. Other retailers may undertake the service on a chargeable basis.

133

## After-sale service

### • Replacement parts

SEIKO makes it a policy to typically keep a stock of replacement parts for this watch for 7 years. Replacement parts are those which are essential to maintaining the functional integrity of the watch. Please keep in mind that if original parts are not available, they may be replaced with substitutes whose outward appearance may differ from the originals.

### • Notes on overhaul

Periodic inspection and adjustment by disassembly and cleaning (overhaul) is recommended approximately once every 3 to 4 years in order to maintain optimal performance of the watch for a long time. According to use conditions, the oil retaining condition of your watch mechanical parts may deteriorate, abrasion of the parts may occur due to contamination of oil, which may ultimately lead the watch itself to stop. As the parts such as gasket may deteriorate, water-resistant performance may be impaired due to intrusion of perspiration and moisture. Please contact the retailer from whom the watch was purchased for inspection and adjustment by disassembly and cleaning (overhaul). For replacement of parts, please specify "SEIKO GENUINE PARTS." When asking for inspection and adjustment by disassembly and cleaning (overhaul), make sure that the gasket and push pin are also replaced with new ones.

134

### • Notes on guarantee and repair

- Contact the retailer the watch was purchased from or SEIKO CUSTOMER SERVICE CENTER for repair or overhaul.
- Within the guarantee period, present the certificate of guarantee to receive repair services.
- Guarantee coverage is provided in the certificate of guarantee. Read carefully and retain it.

135

## How to conduct manual reception (Receiving a radio signal manually)

### 1 Placing the watch

- ▶ When receiving a radio signal, place the watch where it can easily receive a signal.

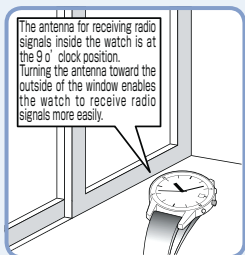

→ To enable the watch to easily receive a radio signal page 99

### 2 Keep pressing Button A until the second hand has finished its movement to the zero second position (Four seconds).

- ▶ When the second hand has moved to the zero second position, the watch will start to receive a radio signal.



Keep pressing Button A for four seconds.

※ How to use button A and B → page 90

- ※ When the time difference is set for a region other than radio signal reception range, a radio signal cannot be received manually (The second hand does not move to the zero second position). Check the time difference set currently. → How to set the time zone pages 106-107

### 3 Do not move the watch while receiving a radio signal.

※ The reception of a radio signal cannot be conducted unless the watch is still.

It takes 12 minutes at the longest according to the receiving state of a radio signal.

- ▶ After about one minute from the start of receiving a radio signal, the second hand will start to indicate the receiving level.

#### Display during reception

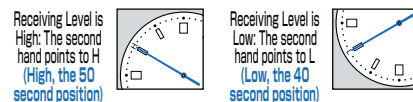

Receiving Level is High: The second hand points to H (High, the 50 second position)  
Receiving Level is Low: The second hand points to L (Low, the 40 second position)

Reception level is updated by moving the second hand every one minute.  
※ The minute hand moves by one minute along with the movement of the second hand.

- ※ It is difficult to receive the signals in some receiving conditions. → Environments in which it is difficult to receive a radio signal Indication on page 100
- ※ This watch is unable to receive a radio signal outside a reception range → Radio signal reception range on pages 96-98
- ※ When the watch is unable to receive radio signals → If the Reception has failed: The second hand points to N on page 103.

### 4 The watch displays the time when receiving a radio signal and after receiving a signal.

- ▶ Check whether the receiving a radio signal has been successful. → page 102
- ※ During the movement of the date, neither the buttons nor the crown can be operated.

#### Not receivable

If the Reception has failed: The Second Hand Points to "N" (No; the 20 second position)

After five seconds, the watch will resume displaying the time.

## Conditions in which the watch may be unable to receive radio signals

### How to manually set the time

When the watch is used continuously in conditions in which the watch may be unable to receive a radio signal, it can be manually adjusted.

※ When the watch is unable to receive a radio signal, it can move depending on normal quartz movement (accuracy of loss / gain: ± 15 seconds per month).

- When adjusting the time, the date will be accordingly adjusted.
- When the watch receives a radio signal after manual adjustment of the time, it displays the received time.
- When using the watch again in regions in which the watch is able to receive a radio signal, it is recommended to perform "Manual reception." → How to conduct manual reception on pages 136-137

### 1 Pulling the crown to the second click

- ▶ The Second hand moves to point to the "Zero second" position and the watch enters the manual time setting mode.



※ When the crown is a screw lock type, unlock it. → page 91

Pulling the Crown to the Second Click

- ※ When the watch enters the manual time setting mode, the reception results will be indicated as "N," since the reception results data will be lost.

### 2 Press Button A to set the time.

One minute Advance	Press Button A once and then release it.
Continuous Advance	When Button A is kept pressed for two seconds or longer, the hand will start to move. Press Button A again to stop.

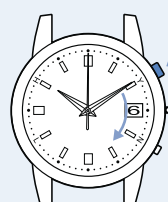

Button A

※ How to use button A and B → page 90  
※ The hand will not move by turning the crown.  
※ Advance the hand to adjust the time. The hand cannot be turned reversely.

- ※ The point in which the date changes at 0:00 AM (12:00 PM). Adjust the time taking into consideration that it is set during the AM and PM.

### 3 Push the crown back in.

- ▶ Operation has been completed. The watch resumes its normal movement.



Pushing the Crown Back In

※ When the crown is a screw lock type, unlock it. → page 91

The watch will resume its normal movement after pushing the crown back in. Push the crown back in according to the time signal.

### How to manually set the date

When the date is not changed due to an environment in which the watch is unable to receive a radio signal (when changing from months with 30 days to months with 31 days or less), adjust the date manually.

- The date can be adjusted independently regardless of the time.
- When the watch receives a radio signal after conducting manual adjustment of the date, it displays the received date.
- When using the watch again in regions in which the watch is able to receive the radio signals, it is recommended to perform "Manual Reception." → How to conduct manual reception on pages 136-137

※ When the date is not correct even if the watch successfully receives a radio signal, the preliminary position of the date may be misaligned. Setting the preliminary position for the date → page 144

### 1 Pulling the crown to the first click

- ▶ The watch enters the manual date setting mode. (The watch keeps moving.)



※ When the crown is a screw lock type, unlock it. → page 91

Pulling the Crown to the First Click

### 2 Press Button A to set the date.

One day Advance	Press Button A once and then release it.
Continuous Advance	When Button A is kept pressed for two seconds or longer, the date will start to move. Press Button A again to stop.

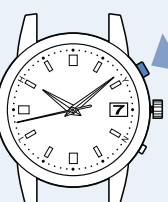

Button A

※ How to use button A and B → page 90  
※ The date will not move by turning the crown.  
※ During movement of the date, the button cannot be operated.

- ※ Adjust the date by advancing the date. The date cannot be reversely moved.

### 3 Push the crown back in.

- ▶ Operation has been completed.



Pushing the Crown Back In

※ When the crown is a screw lock type, lock it. → page 91

## Preliminary position

When the watch is unable to display the precise time or date even if it successfully receives a radio signal with the correct time zone setting, the preliminary position may be misaligned.

The radio-controlled watch can automatically adjust the time, however if the preliminary hand position is an improper one, the watch will be unable to display the precise time even when receiving a radio signal. When comparing the state of "Misaligned Preliminary Hand Position" to that of a weight scale, it is like "a scale which is unable to display the correct weight because its needle is not set to the zero position before weighing."

- **When it is necessary to adjust the preliminary position**  
When displaying a wrong date after receiving a radio signal correctly, or when performing system reset, the preliminary position of the date must be adjusted.  
→ How to set the preliminary position on page 144
- **Function to automatically align the preliminary position of the hand (Automatic hand Position adjustment function)**  
The hand has an "Automatic hand position adjustment function," which automatically corrects a wrong preliminary position. Automatic hand position alignment function activates once a minute for the second hand and at 12:00 both for the AM and PM for the minute and hour hands.  
※ The preliminary position of the hour and minute hands can be adjusted manually.  
Since the preliminary position of the date is not automatically adjusted, it must be adjusted manually.  
※ When the watch is not displaying the precise time and date even after successfully receiving a radio signal due to factors other than above mentioned ones → At Trouble: Misalignment of the time and the hands on page 152, Misalignment of the date on page 154.

### 《Misalignment of the time and date》

- In the case of having a strong impact: Misalignment of the time and date may occur when dropping or hitting the watch.
- In the case of a magnetic influence: Misalignment of the time and date may occur when bringing the watch close to an object which generates magnetism.

#### Things around you which generate magnetism

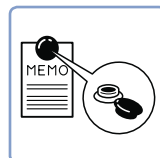

• Magnetic Clip

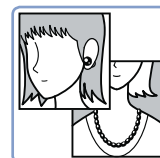

• Accessories using a magnet

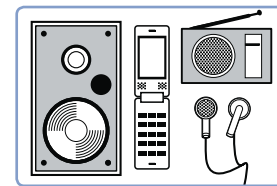

• Magnetic therapy devices (a heating pad, bedding, a lumbago band, etc.)

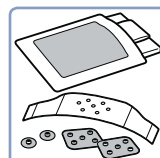

• Magnet of doors for a refrigerator or furniture

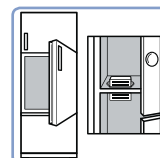

• Speakers used for such as audiovisual apparatus, radio, an earphone, and a cellular phone.

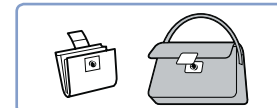

• Clasps for a bag or wallet



## How to set the preliminary position

### Setting the preliminary position of the date

The preliminary position of the date is the "1st."  
When the preliminary position of the date is incorrect, the correct date cannot be displayed even if the watch receives a radio signal.  
Loss or gain of the date can be adjusted by setting the preliminary position of the date as the "1st."

In the case that the numerical number of the date does not locate at the center of the window, it also can be corrected by the same procedures as mentioned above.

When setting the preliminary position of the hour and minute hands right after setting the preliminary position of the date, after completing procedure 2 of preliminary position setting of the date, go to procedure 2 on page 147.

#### 1 Press and hold Button A and Button B simultaneously until the second hand stops at the 13-second position (for four seconds).

The date will start to advance and stop at the preliminary position.

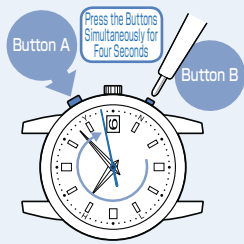

※ Never pull the crown out.

※ How to use button A and B → page 90

※ In order to perform the procedures easily, it is recommended to first press and hold Button B, and then press Button A.

- While dates are advancing, no button operation can be made.
- After the date stops, when the watch has no operation and no movement of the hands for ten seconds or longer, it automatically displays the time again.
- When it is in the middle of operation, re-attempt the operation from procedure "1."

#### 2 Pressing Button B to set the date to the "1."

Set the preliminary position to the precise date.  
Adjust the date so that the position of "1" will locate at the center of the window.

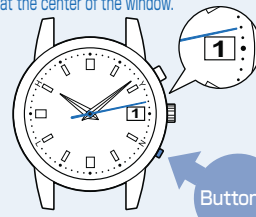

Continuous advancement	If Button B is kept pressed for two seconds or longer, the dates advance continuously. Press Button B again to stop.
Fine-tuning:	Each pressing of Button B advances the date gradually.

※ The date can only be advanced. It cannot be turned back.

#### 3 Automatic mode termination

When the date movement stops, the preliminary position adjustment mode will be terminated in ten seconds.

Confirm whether the date is correct after the watch resumes displaying time.  
In the case that the date is not correct, adjust the date.

Adjusting the date by receiving a radio signal.

How to conduct manual reception → page 136

If the watch is unable to receive radio signals  
How to manually set the date → page 140

### Setting the preliminary positions of the hour and minute hands manually

No button operation is needed if setting the hands to the preliminary positions automatically.

→ Automatic hand position alignment function on page 142

Conduct the following procedures when setting the hour and minute hands manually.

When setting the preliminary position of the hour and minute hands right after setting the preliminary position of the date, after completing procedure "2" of preliminary position setting of the date on page 145, go to procedure "2."

#### 1 Press and hold Button A and Button B simultaneously until the second hand stops at the 13-second position (for four seconds).

The watch enters the mode to adjust the preliminary position of the date.

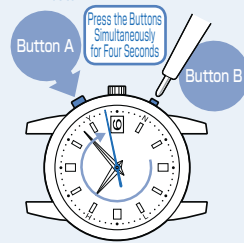

※ Never pull the crown out.

※ How to use button A and B → page 90

※ In order to perform the procedures easily, it is recommended to first press and hold Button B, and then press Button A.

- While dates are advancing, no button operation can be made.
- After the date stops, when the watch has no operation and no movement of the hands for ten seconds or longer, it automatically displays the time again.
- When it is in the middle of operation, re-attempt the operation from procedure "1."

#### 2 After the date stops, press and hold Button A until the second hand stops at the 0-second position (for two seconds).

Enter the mode to adjust the preliminary positions of the hour and minute hands.

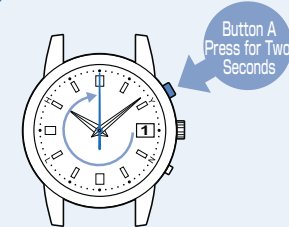

- While dates are advancing, no button operation can be made.
- After the date stops, when the watch has no operation and no movement of the hands for ten seconds or longer, it automatically displays the time again.
- When it is in the middle of operation, re-attempt the operation from procedure "1."

#### 3 Press Button B Once.

The preliminary positions of the hour and minute hands are automatically adjusted. The hour and minute hands start to move, and then all hands will stop at the 0-second position.

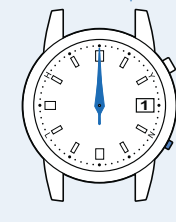

After 10 seconds when the all hands will stop at the 0-second position, the watch will return to display the time.

## Troubleshooting

Troubles		Possible causes	Solutions	Reference page
Movement of the watch hands	The second hand moves at two-second intervals.	The energy depletion forewarning function is activated. (page 112)	Sufficiently charge the watch until it starts moving at one-second intervals.	page 110
	The second hand moves at five-second intervals.	If this function is activated even though you wear the watch everyday, the watch may be unable to receive sufficient light because it is concealed under a long sleeve shirt, etc.	Make sure that the watch is not concealed under a sleeve while you are wearing the watch. When taking the watch off, place the watch in a location as bright as possible.	
	The stopped second hand pointing to the 15-second position started moving.	The Power Save has been activated to limit energy consumption. (page 113) When the watch is used or stored continually under conditions where it cannot receive sufficient light, the power save function is automatically activated in order to reduce unnecessary energy consumption.	Wait until the watch returns to the current time display. Use the watch as it is (this is not a malfunction).	—
	The stopped second hand pointing to the 45-second position started moving.	The Power Save has been activated to limit energy consumption. (page 113) When the watch is used or stored continually under conditions where it cannot receive sufficient light, the power save function is automatically activated in order to reduce unnecessary energy consumption.	① Sufficiently charge the watch until it starts moving at one-second intervals. ② Set the time, date and day.	page 110 page 95
	The watch hands were fast-forwarded even though no button had been pressed, and then the watch resumed regular movement.	The Power Save function has been activated. (page 113) The automatic hand alignment function has been activated. (page 142) When the hand positions deviate to display incorrect time as a result of influence of various external sources, the watch automatically corrects the hand alignment itself.	Use the watch as it is (this is not a malfunction).	—

At trouble		Possible causes	Solution	Reference page
Reception of a radio signal	When the watch is unable to receive a radio signal	The watch was moved while it was receiving a radio signal.	Do not move the watch while it is receiving a radio signal. The reception of the radio signals cannot be conducted unless the watch is still.	page 99
		The watch was left where the radio signal was weak or where it was unable to receive a radio signal (page 100).	Place the watch where it is able to easily receive a radio signal.	page 99
	The reception results have failed and the second hand points to N (the watch does not receive a radio signal).	Transmitting stations may have stopped transmitting radio signals for some reason (Transmission stop).	Check the website of each transmitting station for further information concerning a transmission stop. Attempt to receive a radio signal again after a while.	page 101
Charging the solar battery	The stopped watch was exposed to an adequate light for longer than "the time required to fully charge the watch," however, it does not resume its normal one-second interval movements.	The light is too weak or the manner of lighting the watch has been altered while the watch is being charged.	Charge the watch in an environment where the watch can be exposed to an adequate intensity of light in a stable condition.	page 110
		The Built-in IC of the watch has fallen into an unstable condition.	Refer to the "In Case of an Abnormal Movement" section and perform the operations as instructed.	page 156

At Trouble		Possible causes	Solution	Reference pages
Misalignment of the time and hand positions	The watch temporarily gains or loses time.	The watch fails to receive a radio signal correctly as a result of external influence (incorrect reception).	① Place the watch where it is able to receive a radio signal more easily. ② Conduct manual reception if necessary.	page 99 page 136
		The watch has been left in an extremely high or low temperature place for a long time.	① When the watch returns to a normal temperature, it will display the precise time as before. ② If the watch still gains or loses the time, conduct manual reception if necessary. ③ If the watch cannot resume normal movement even after conducting the above mentioned procedures, consult the retailer from whom the watch was purchased.	— page 136 —
	The watch displays an incorrect time hour unit, even though it displays the precise time of minutes and seconds	The watch may be set to a time in a different time zone from the region where the watch is currently used.	Check the time zone that the watch is currently set for, and select the right time zone.	page 106
	The reception results are successful, but the precise time is not displayed.	The hand positions were misaligned as a result of external influence. The hands are out of the preliminary position as a result of external influence. → Preliminary position on page 142	① No crown or button operation is needed, since the automatic hand position adjustment function will be activated to align the hand positions. Automatic Hand Position Adjustment Function activates once a minute for the second hand and at 12:00 both for the AM and PM for the minute and hour hands. If you are in a hurry, the preliminary position of the hour and minute hands can be adjusted manually.	page 142
	The second hand position is not correctly aligned in "the reception results display" or "the reception level display."	The second hand is out of the preliminary position as a result of external influence. → Preliminary position on page 142	② If the misalignment of the hand is not corrected, refer to the "In case of an abnormal movement" section and perform the operations as instructed. ③ If the misalignment of the hand is not corrected even after performing the operations as instructed in the ②, consult the retailer from whom the watch was purchased.	page 156 —

At Trouble		Possible causes	Solution	Reference pages
Misalignment of the date	The reception result display confirms successful reception, and the correct time is displayed, but the wrong date is displayed.	The date is out of preliminary position. This happens when the date is out of preliminary position as a result of influence of various external sources or after the built-in IC is reset.	Check if the date is set to the correct preliminary position. If not, correct the preliminary position for date.	page 144
Operation	The crown or buttons cannot be operated.	The stored electric power is running short.	Sufficiently charge the watch until it starts moving at one-second intervals.	page 110
	You get lost in the middle of the operation.	Date and day are moving right after a setting is carried out by the crown or button operation.	Wait for a while without doing anything.	—
	Blur on the dial glass persists.	Small amount of water has got inside the watch due to deterioration of the gasket, etc.	Contact the retailer from whom the watch was purchased.	—

\* For the solution of troubles other than the above, consult the retailer from whom the watch was purchased.

## In case of an abnormal movement

In the case that the watch moves abnormally or that the watch does not move at one-second intervals even after fully charging the battery, perform the procedures from ① - ⑥ to re-establish normal function.

### How to reset the Built-in IC, (① - ③)

① When pulling the crown to the second click, the second hand stops at the zero second position.

※ When the crown is a screw lock type, unlock it. → page 91

② Press and hold Button A and Button B simultaneously for four seconds, and then release them.

▶ In five seconds after releasing the buttons, the second hand makes a full rotation and stops at the zero second position. Then the hands of the hour and minute will start to move toward the Zero second position.

▶ Press and hold Button A and Button B simultaneously for four seconds

▶ How to use button A and B → page 90

※ In order to perform the procedures easily, it is recommended to first press and hold Button B, and then press Button A.

### Adjusting the preliminary position of the date (④~⑥)

③ When all the hands return to the zero second position, push the crown back in.

▶ The second hand will start to move from 0:0:0 AM

▶ Push the crown back in

※ When the crown is a screw lock type, unlock it. → page 91

④ Press and hold Button A and Button B simultaneously until the second hand stops at the 13-second position (for four seconds).

▶ The watch enters the mode to adjust the preliminary position of the date.

▶ Press Button A and Button B simultaneously for four seconds

▶ Never pull the crown out

• When the watch has no operation for ten seconds or longer, the mode automatically terminates.  
• When it is in the middle of operation, re-attempt the operation from procedure "4."

Go on to the next page

### ⑤ Pressing Button B to Set the Preliminary Position to the "1."

▶ Adjust the date so that the position of "1" will locate at the center of the window.

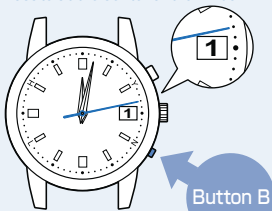

The preliminary position adjusting mode terminates 10 seconds after the procedure "5" has been completed.

Continuous advancement	Each pressing of Button A advances the date by one day. If Button A is kept pressed for the dates advance continuously. Press Button A again to stop it.
Fine-tuning	Continuous advancement: If Button B is kept pressed for two seconds or longer, the dates advance continuously. Press Button B again to stop.
	Each pressing of Button B advances the date gradually.

### Setting the time zone (⑥~⑦)

#### ⑥ Press and hold Button B until the second hand moves (for four seconds) to the 0-second position.

▶ The watch enters the time zone adjustment mode.

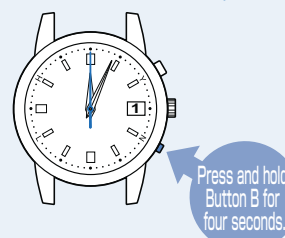

When a no movement state of the second hand is kept for ten seconds or more, the watch automatically switches to the time display state.  
When it is in the middle of operation, re-attempt the operation from procedure "6."

Go on to the next page

**7** Set the time zone by pressing the button to move the second hand (selecting a transmitting station).

▶ Set the time zone of the area where the watch is used.

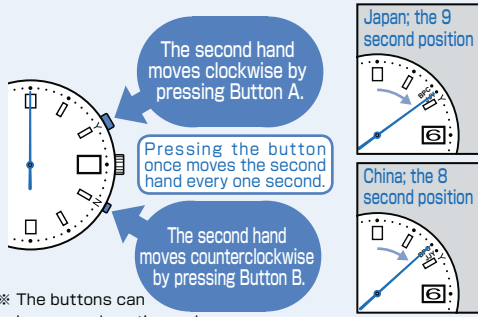

※ The buttons can be pressed continuously.

Other areas: List of major time zones around the world → page 108

The time zone adjusting mode terminates 10 seconds after the procedure "7" has been completed.

**8** Set the Time

Set the time by receiving a radio signal.

How to conduct manual reception → page 136

If the watch is unable to receive radio signals

How to manually set the time → page 138

The operation has been completed when setting the time.

**Specifications**

1. Frequency of crystal oscillator ..... 32,768 Hz (Hz = Hertz ... Cycles per second)
2. Loss/gain (monthly rate) ..... Loss / gain ± 15 seconds on a monthly rate (Except the case when the watch is used without an automatic time setting by receiving a radio signal and when it is worn on the wrist within a normal temperature range between 5°C and 35°C).
3. Operational temperature range ..... Between -10°C ~ +60°C
4. Driving systems ..... Step motor (Hour and minute hands, second hand, and the date)
5. Power source ..... Secondary battery, 1 piece
6. Duration of operation ... Approximately six months (Fully charged, and the Power Save is not activated).  
 ※ If the Power Save is activated after it is fully charged, the watch continues to run for approximately one year and a half at maximum.
7. Time setting by receiving the JJY-LF radio signal ... Automatic reception (at 2:00 AM 3:00 AM and 4:00 AM)  
 ※ Reception attempts depend on the radio signal receiving conditions.  
 ※ After having received a radio signal, the watch will start to move depending on the quartz movement until the next reception.  
 ※ Manual reception is also possible
8. IC (Integrated Circuit) ... Oscillator, frequency divider and driving circuit C-MOS-IC, 3 pieces  
 ※ The specifications are subject to change without prior notice for product improvement.

通話料無料 0120-612-911

お客様相談室

〒100-0005 東京都千代田区丸の内 3-1-1 国際ビル  
 〒550-0013 大阪市西区新町 1-4-24 大阪四ツ橋新町ビルディング

セイコーウォッチ株式会社

<https://www.seikowatches.com/>