

S064

KSJS064-A2304

セイコーウォッチ株式会社

SEIKO

取扱説明書

I N S T R U C T I O N S

S064 ストップウォッチ ソーラー NFC データ通信

Thank you very much for choosing a SEIKO watch.
For proper and safe use of your SEIKO watch,
please read carefully the instructions
in this booklet before using it.

Keep this manual handy for easy reference.

Contents

<p>Handling cautions44</p> <p>Features48</p> <p>Names of the buttons and mode change</p> <p style="padding-left: 20px;">①Names of the buttons49</p> <p style="padding-left: 20px;">②Mode change50</p> <p>How to use the stopwatch</p> <p style="padding-left: 20px;">①Names of the buttons and their functions51</p> <p style="padding-left: 20px;">②Accumulated elapsed time measurement52</p> <p style="padding-left: 20px;">③Lap time measurement53</p> <p style="padding-left: 20px;">④Running lap time measurement ...54</p>	<p style="padding-left: 20px;">⑤Split time measurement55</p> <p style="padding-left: 20px;">⑥300-Lap/ Split memory recall function ...56</p> <p>How to use data display</p> <p style="padding-left: 20px;">①Names of the buttons and their functions58</p> <p style="padding-left: 20px;">②Switch the channel59</p> <p style="padding-left: 20px;">③Check the lap data in the channel59</p> <p>Time/Calendar display</p> <p style="padding-left: 20px;">①Names of the buttons and their functions60</p> <p style="padding-left: 20px;">②How to set the time and</p>
---	---

<p style="padding-left: 20px;">calendar61</p> <p style="padding-left: 20px;">③How to adjust the contrast ...62</p> <p>Power save function, sleep function63</p> <p>System reset.....64</p> <p>Data communication65</p> <p style="padding-left: 20px;">①How to communicate data65</p> <p style="padding-left: 20px;">②Precautions for data communication.....65</p> <p style="padding-left: 20px;">③Precaution for data handling ...65</p> <p>About charging</p> <p style="padding-left: 20px;">①How to charge66</p> <p style="padding-left: 20px;">②Charging time68</p> <p style="padding-left: 20px;">③Battery icon and remaining battery level69</p>	<p style="padding-left: 20px;">④Power save function, sleep function71</p> <p>Water resistance72</p> <p>Daily care74</p> <p>Power source75</p> <p>After-sales service.....77</p> <p>Specifications79</p>
--	--

Handling cautions

WARNING

To indicate the risks of serious consequences such as severe injuries unless the following safety regulations are strictly observed

- **Keep the watch and accessories out of the reach of babies and children.**
Care should be taken to prevent a baby or a child accidentally swallowing the accessories.
If a baby or a child swallows the battery or accessories, immediately consult a doctor, as it will be harmful to the health of the baby or child.
- **Do not remove the secondary battery from the watch.**
※ About the secondary battery → Power source page 75
Replacement of the secondary battery requires professional knowledge and skill.
Please ask the retailer from whom the watch was purchased for replacement of the secondary battery.
Installation of an ordinary silver oxide battery can generate heat that can cause bursting and ignition.

CAUTIONS

To indicate the risks of light injuries or material damages unless the following safety regulations are strictly observed.

- **Avoid wearing or storing the watch in the following places.**
 - Places where volatile agents (cosmetics such as polish remover, bug repellent, thinners etc.) are vaporizing
 - Places where the temperature drops below 5 °C or rises above 35 °C for a long time
 - Places of high humidity
 - Places affected by strong magnetism or static electricity Dusty places
 - Places affected by strong vibrations
- **If you observe any allergic symptoms or skin irritation**
Stop wearing the watch immediately and consult a specialist such as a dermatologist or an allergist.
- **Other cautions**
 - Do not disassemble or tamper with the watch.
 - Keep the watch out of the reach of babies and children. Extra care should be taken to avoid risks of any injury or allergic rash or itching that may be caused when they touch the watch.
 - When disposing of used batteries, follow the instructions of your local authorities.
 - The strap or chain attached to the watch may damage your clothes, or injure the hand, neck, or other parts of your body.

⚠ WARNING



Do not use the watch in scuba diving or saturation diving.

The various tightened inspections under simulated harsh environment, which are usually required for watches designed for scuba diving or saturation diving, have not been conducted on this watch. For diving, use special watches for diving.

⚠ CAUTION



Do not pour running water directly from faucet onto the watch.

The water pressure of tap water from a faucet is high enough to degrade the water resistant performance of a water resistant watch for everyday life.

⚠ CAUTION

Do not turn or pull out the crown when the watch is wet.
Water may get inside of the watch.

※ If the inner surface of the glass is clouded with condensation or water droplets appear inside of the watch for a long time, the water resistant performance of the watch is deteriorated. Immediately consult the retailer from whom the watch was purchased or SEIKO CUSTOMER SERVICE CENTER.

Do not leave moisture, sweat and dirt on the watch for a long time.

Be aware of a risk that a water resistant watch may lessen its water resistant performance because of deterioration of the adhesive on the glass or gasket, or the development of rust on stainless steel.

Do not wear the watch while taking a bath or a sauna.
Steam, soap or some components of a hot spring may accelerate the deterioration of water resistant performance of the watch.

Features

The Seiko Quartz Stopwatch Cal. S064 is a stopwatch with a solar charging function, featuring the NFC data communications function. This watch can store up to 300 lap records. If the number of records is 300 or less, they can be divided and stored.

The NFC data communications function enables lap records in the watch to be transferred to a PC as data via the NFC reader (dedicated application is required).

- Stopwatch function: The stopwatch can measure up to 100 hours in 1/100-second increments.
- The stopwatch function has selectable display modes: split time, lap time and running lap time.
- Memory recall function: If the number of records is 300 or less, they can be divided and stored. Also each group of records stores channel (REC) number and start date/time of measurement. When the number of records exceeds 300, the data in the oldest channel is automatically deleted.
- If only one channel is used, 300 lap records can be stored. However, if multiple channels are used, the total number of stored lap records will not reach 300.
- *For example, when only one channel is used, 300 lap records can be stored, when 2 channels are used, 296 lap records can be stored.
- In the time/calendar display, current time, year, month, date and day of the week are displayed.
- Power save function: When the watch is not operated for longer than a pre-set time, the display is automatically turned off to save energy consumption.

[Duration of operation by solar energy]

Once fully charged, the watch can operate for approximately 6 months without being exposed to light. (Operating life is estimated under the conditions that the stopwatch is used for less than 3 hours, the power save function is activated for 20 hours and the data communication is carried out 3 times or less per day.)

Names of the buttons and mode change

① Names of the buttons

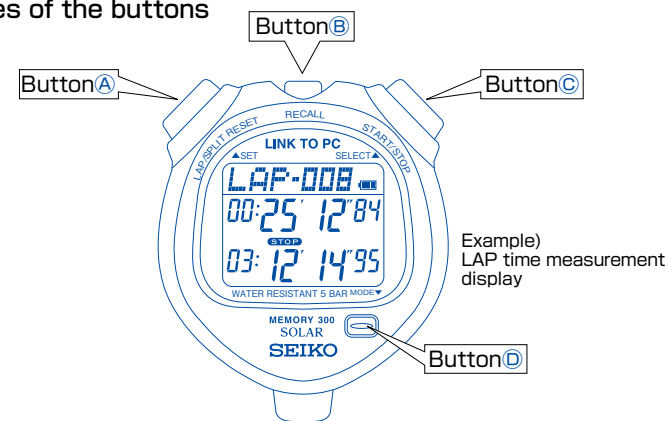

② Mode change

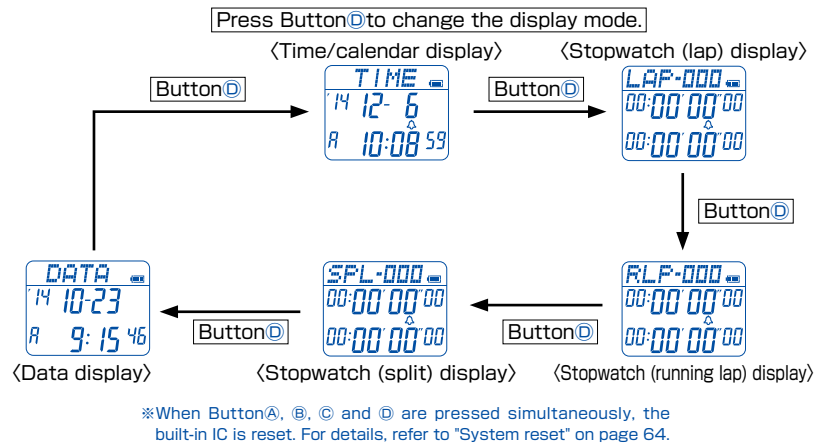

How to use the stopwatch ① Names of the buttons and their functions

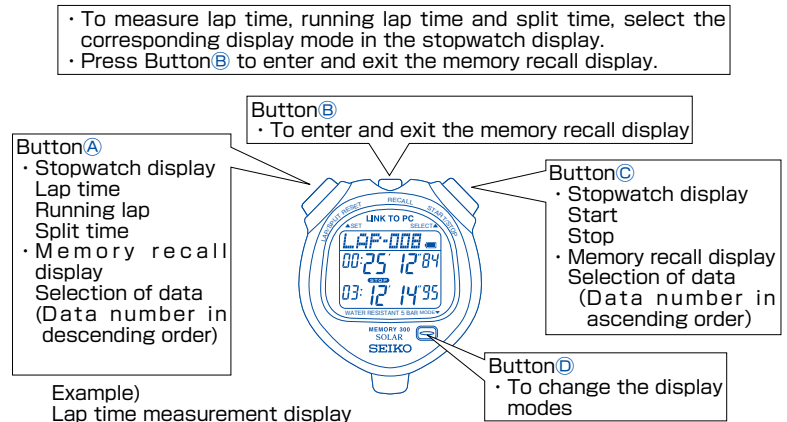

② Accumulated elapsed time measurement

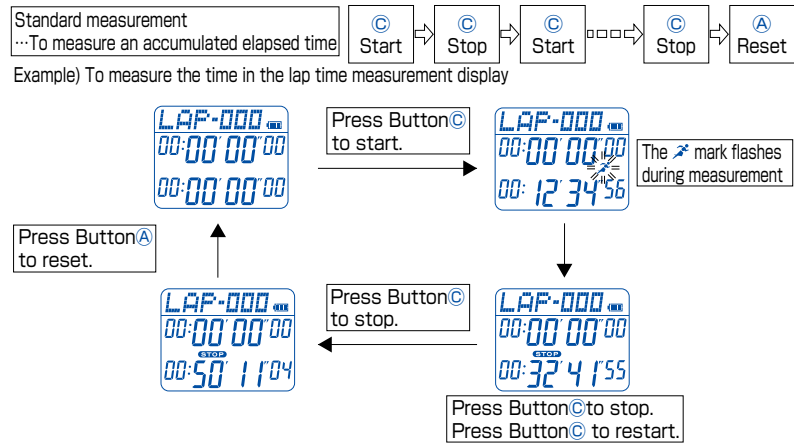

③ Lap time measurement

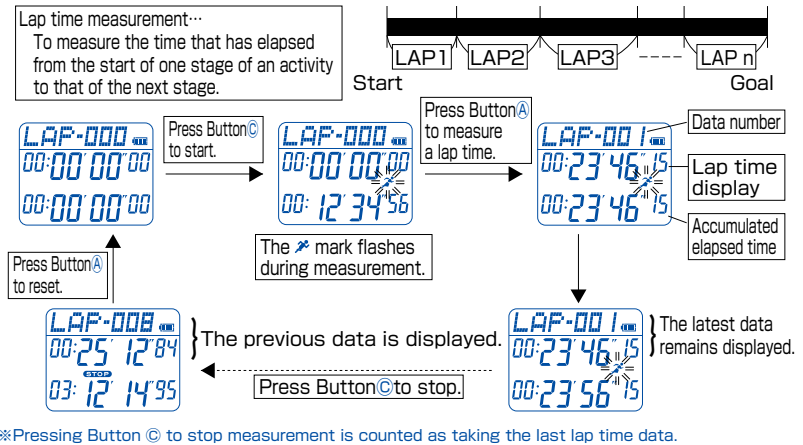

How to use data display ① Names of the buttons and their functions

Up to 300 lap records measured in the stopwatch display are divided and stored in the watch when the stopwatch function is reset.

① Names of the buttons and their functions

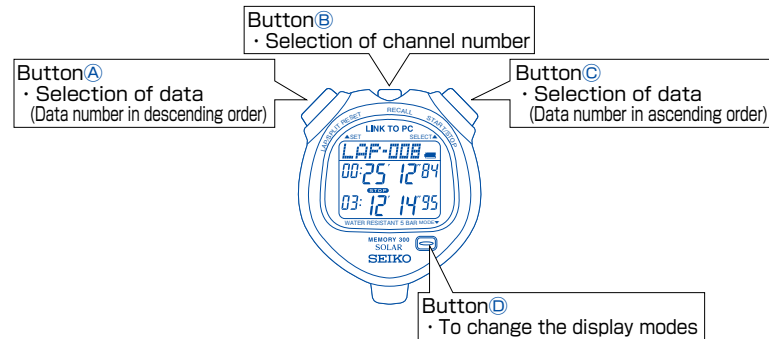

58

② Switch the channel ③ Check the lap data in the channel

② Switch the channel

Press Button **B** to enter the data display.

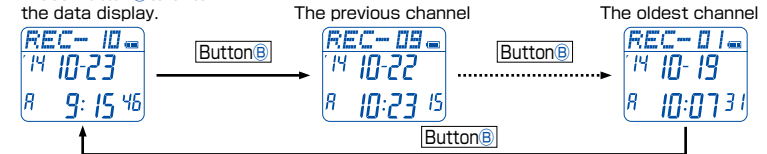

③ Check the lap data in the channel.

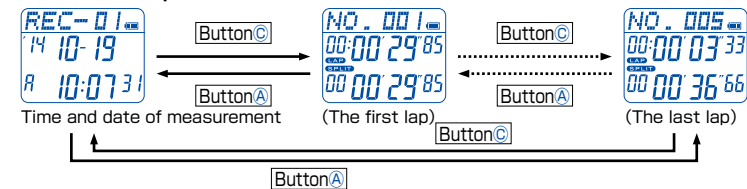

59

Time/Calendar display ① Names of the buttons and their functions

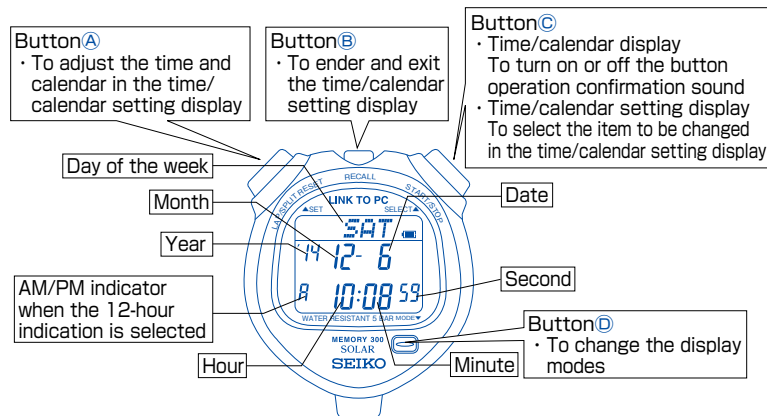

*When the button operation confirmation sound is turned on, the mark is displayed.

60

② How to set the time and calendar

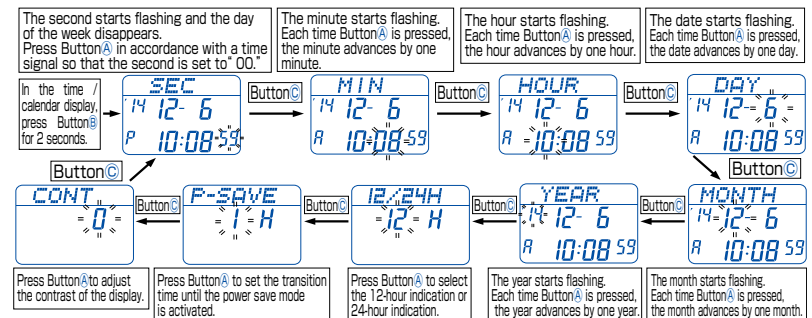

- *Keep Button **A** pressed to quickly increase the value for the minute, hour, date, month and year. The value increases quickly as long as Button **A** is kept pressed.
- *Press Button **B** to exit the time/calendar setting display. Even if Button **B** is not pressed, the display automatically exits the time/calendar setting display within 2 to 3 minutes.
- *When the year, month and date are set, the day of the week is automatically set.
- *In the time/calendar setting display, if Button **A** and **C** are simultaneously pressed, all the digital segments are turned on. This is not a malfunction. Press any of Button **A**, **B**, **C** or **D** to return to the time/calendar display.
- *The transition time until the power save mode is activated can be selected from among 1 hour (1H), 3 hours (3H), 6 hours (6H) and 12 hours (12H). The default setting is 1 hour (1H).

61

③ How to adjust the contrast

· The contrast of the display can be adjusted. After initialization or when all the settings are cleared, the contrast is returned to its default setting of "0."

● Press Button **D** to enter the time/calendar display.

① Keep pressing Button **B** to enter the time/calendar setting display. The current time is displayed.

② Press Button **C** to enter the contrast setting display.

③ Press Button **A** to adjust the contrast.

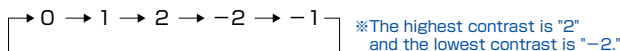

④ When contrast adjustment is finished, press Button **B** to return to the time/calendar display. Even if Button **B** is not pressed, the display automatically returns to the time/calendar display within 2 to 3 minutes.

62

System reset

· When an abnormal display (broken digits, etc.) appears, follow the procedure below. The built-in IC is reset and the watch resumes normal operation.

· How to reset the IC

Press Button **A**, **B**, **C**, **D** at the same time for 2 to 3 seconds. The display content disappears, and then "WED' 14 1-1 A 12:00 00" is displayed.

※After the IC is reset, all the stored data are deleted. Settings of the time and date etc. are also required.

64

Power save function, sleep function

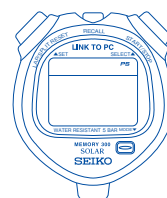

Power Save mark : PS
When the watch enters the power save mode, the PS indicator flashes.



After 72 hours

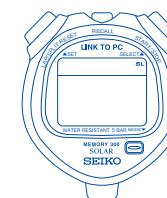

Sleep mode mark : SL
When the watch enters the sleep mode, the SL indicator flashes.

In the time/calendar setting mode, the transition time until the power save mode is activated can be set. The following energy saving functions are provided to extend the battery life.

- The transition time until the power save mode is activated can be selected from among 1 hour (1H), 3 hours (3H), 6 hours (6H) and 12 hours (12H). For instructions on this setting, refer to "How to set the time/calendar." The default setting is 1 hour (1H).
- In any display mode, if no operation is performed for a pre-set time, the power save function is automatically activated and the display is turned off.
- When the stopwatch is operating, the display is not turned off.
- When the watch is in the NFC communications mode for 3 minutes, it enters the power save mode.
- To turn the display on, press any of Button **A**, **B**, **C**, **D**. The display returns to the display right before the power save function is activated.
- When the watch is in the power save mode for longer than 72 hours, it automatically enters the sleep mode, in which more efficient energy saving is achieved. When the watch enters the sleep mode, the stopwatch is reset.

63

Data communication

The NFC data communications function of this watch enables the lap records in the watch to be transferred to a PC as data via the NFC reader.



The dedicated NFC reader manufactured by Seiko Watch Corporation [SVAZ015] (optional) is required for data communication. Perform data communication after installing the dedicated application on a PC. The application can be downloaded from the Seiko Watch Corporation website. ((For Windows® 7 / Windows® 8 / Windows® 10 / Windows® 11)) In addition, an environment connected to the Internet is required for use of the application.

①How to communicate data

- Prepare the stopwatch [SVAJ701], NFC reader [SVAZ015] and PC with the dedicated application installed.
- Correctly connect the NFC reader to the USB port of a PC to start the dedicated application.
- Put the stopwatch of which data will be transferred on the reader. The data in the watch is automatically transferred.

②Precautions for data communication

- If the stopwatch is not sufficiently charged, no data will be transferred.
- No data during measurement and no undefined data (before reset) are transferred.

③Precaution for data handling

- Make sure to backup important data.

For details, please read the operation manuals of the "NFC reader" and "application."

65

About charging ① How to charge

Expose the solar panel to light.

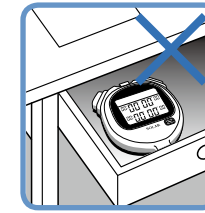
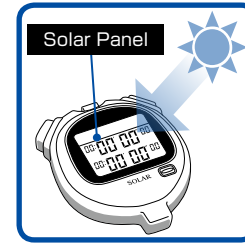
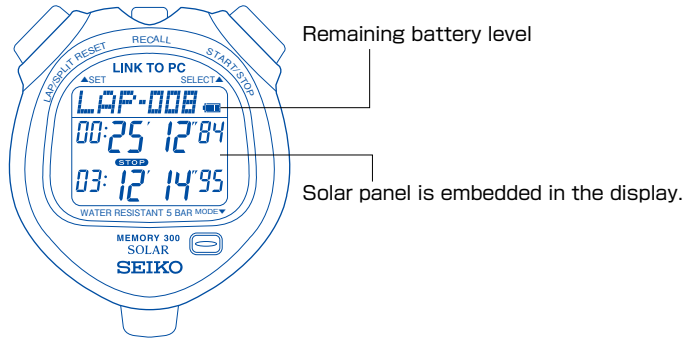

To enjoy optimal performance of the watch, it is recommended that the watch be kept sufficiently charged at all times.

Under the following conditions, the watch may stop because of the energy depletion caused by insufficient battery charge.

- When the watch is kept in a place like locker or drawer where light is insufficient
- When the watch is left with its display facing down

※ When charging the watch, make sure that the watch temperature does not rise too high. The operational temperature range is between -10.C and +60.C.

※ When you start using the watch for the first time, or when the watch is completely stopped due to energy depletion, charge the watch for a sufficient time, referring to the table on the next page.

66

67

② Charging time

Charge the battery, referring to the table below as a guide.

LCD display	Blank	Flashing	Flashing			To run the watch for one day
Environment 1 Outdoor on a sunny day 100000 lux	Approximately 1.4 hours			Approximately 11 hours	Approximately 6 hours	Approximately 5 minutes
Environment2 By the window on a sunny day 10000 lux	Approximately 13.5 hours			Approximately 108 hours	Approximately 57 hours	Approximately 55 minutes
Environment3 By the window on a cloudy day 5000 lux	Approximately 28.5 hours			Approximately 220 hours	Approximately 102 hours	Approximately 95 minutes
Environment4 Indoor under fluorescent light 500 lux	Approximately 12 days					Approximately 15 hours

Once fully charged, the watch keeps operating for approximately 6 months without being recharged when it is used under the following conditions.

- The stopwatch function is used for less than 3 hours per day.
- Power save function is activated for 20 hours per day.
- The data communication is carried out 3 times or less per day

※When you start using the watch for the first time, or when the watch is completely stopped due to battery depletion, charge the watch for a sufficient time, referring to the table on the previous page.

68

③ Battery icon and remaining battery level

■ Remaining battery level

The battery icon on the display lets you know the remaining battery level.

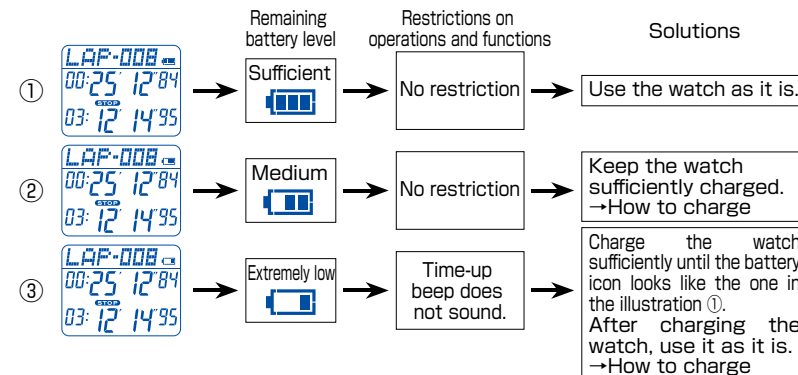

69

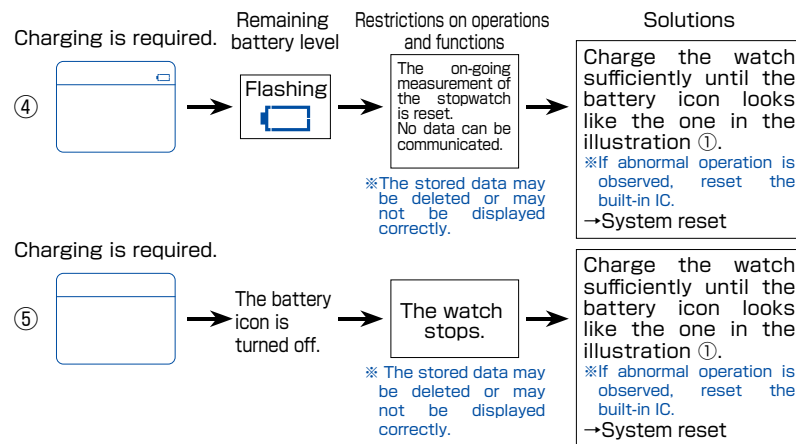

70

④ Power save function, sleep function

When no button is pressed for longer than a certain period, the power save function (energy saving function) and sleep function are activated.

※How to set the transition time to the power save mode

The transition time until the power save mode is activated can be selected from among 1 hour, 3 hours, 6 hours and 12 hours in the time/calendar setting mode. The default setting is 1 hour. For instructions on this setting, refer to "How to set the time/calendar."

When you use the stopwatch function in a dark place, it is recommended that the transition time to the power save mode be set to a time longer than the time the stopwatch is used.

■ Display and functions during the power save mode

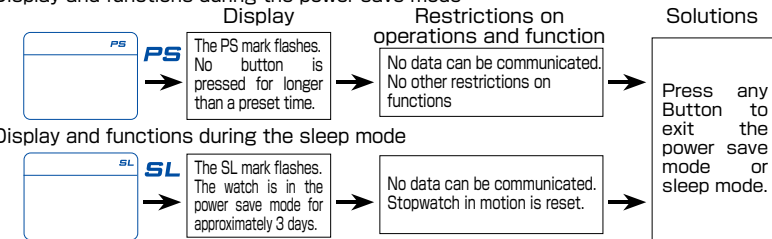

71

Water resistance

Refer to the table below for the description of each degree of water resistant performance of your watch before using.

Indication on the case back	Water resistant performance	Condition of use
No indication	Non-water resistance	Avoid drops of water or sweat
WATER RESISTANT	Water resistance for everyday life	The watch withstands accidental contact with water in everyday life.  WARNING Not suitable for swimming
WATER RESISTANT 5 BAR	Water resistance for everyday life at 5 barometric pressures	The watch is resistant to splashes when worn during sports that may expose the watch to water.
WATER RESISTANT 10 (20) BAR	Water resistance for everyday life at 10(20) barometric pressures.	The watch is resistant to raindrops and splashes when worn during sports that may expose the watch to water.

※ Do not operate the buttons underwater.

72

73

Daily care

● The watch requires good daily care

- Wipe away moisture, sweat or dirt with a soft cloth
- After soaking the watch in seawater, be sure to wash the watch in clean pure water and wipe it dry carefully. Do not pour running water directly from faucet onto the watch. Put some water into a bowl first, and then soak the watch in the water to wash it.
 - ※ If your watch is rated as "Non-water resistant" or "water resistant for everyday life," do not wash the watch.
 - Water resistance page 72

74

※ Overcharge prevention function

When the secondary battery is fully charged, the overcharge prevention function is automatically activated to avoid further charging. There is no need to worry about damage caused by overcharging no matter how much the secondary battery is charged in excess of the "time required for fully charging the watch".

※ Refer to "Charging time" on page 28 to check the time required for fully charging the watch.

▲ NOTICE

■ Notes on charging the watch

- When charging the watch, do not place the watch in close proximity to an intense light source such as lighting equipment for photography, spotlights or incandescent lights, as the watch may be excessively heated resulting in damage to its internal parts.
- When charging the watch by exposure to direct sunlight, avoid places that easily reach high temperatures, such as a car dashboard.
- Always keep the watch temperature under 50 °C.

76

Power source

The battery used in this watch is a special secondary battery, which is totally different from ordinary silver oxide batteries.

Unlike other disposable batteries such as dry-cell batteries or button cells, this secondary battery can be used over and over again by repeating the cycles of discharging and recharging.

However, for various reasons such as long-term use or usage conditions, the capacity or recharging efficiency of the secondary battery may gradually deteriorate. If the efficiency of the secondary battery decreases, have the watch repaired.

▲ NOTICE

■ Remarks on replacing the secondary battery

- Do not remove the secondary battery yourself.
Replacement of the secondary battery requires professional knowledge and skill. Please ask the retailer from whom the watch was purchased for repair.
- Installation of an ordinary silver oxide battery can generate heat that can cause bursting or ignition.

75

After-sales service

● Notes on guarantee and repair

- Contact the retailer from whom the watch was purchased or SEIKO CUSTOMER SERVICE CENTER for repair or overhaul.
- Within the guarantee period, present the certificate of guarantee to receive repair services.
- Guarantee coverage is provided in the certificate of guarantee. Read carefully and retain it.
- For repair services after the guarantee period has expired, if the functions of the watch can be restored by repair work, we will undertake repair services upon request and payment.

● Replacement parts

- SEIKO makes it a policy to typically keep a stock of replacement parts for this watch for 7 years. Replacement parts are those which are essential to maintaining the functional integrity of the watch.
- Please keep in mind that if original parts are not available, they may be replaced with substitutes whose outward appearance may differ from the originals.

77

● Inspection and adjustment by disassembly and cleaning (overhaul)

- Periodic inspection and adjustment by disassembly and cleaning(overhaul) are recommended approximately once every 3 to 4 years in order to maintain optimal performance of the watch for a long time.

According to use conditions, the digital display may go out due to liquid leakage. As the parts such as the gasket may deteriorate, water-resistant performance may be impaired due to intrusion of perspiration and moisture.

Please contact the retailer from whom the watch was purchased for inspection and adjustment by disassembly and cleaning (overhaul). For replacement of parts, please specify "SEIKO GENUINE PARTS." When asking for inspection and adjustment by disassembly and cleaning (overhaul), make sure that the gasket are also replaced with new ones.

- When your watch is inspected and adjusted by disassembly and cleaning (overhauled), the movement of your watch may be replaced.

● Liquid crystal panel

The normal life expectancy for the liquid crystal panel of this watch is approximately 7 years. After that, it may decrease in contrast, becoming difficult to read.

Please contact the retailer from whom the watch was purchased to have the liquid crystal panel replaced with a new one. It will be replaced at your cost.

Specifications

1. Frequency of crystal oscillator : 32,768Hz (Hz = Hertz Cycles per second)
2. Loss/gain (monthly rate) : Less than 0.0012% or 30 seconds at normal temperature range between 5 °C and 35 °C)
3. Operational temperature range : between -10 °C and +60°C
4. Temperature range for display function : between 0 °C and +50 °C
5. Display :
Watch display : Day of the week, Year, Month, Date, Hour, Minute, Second (Fully automatic calendar from January 1, 2014 to December 31, 2063)
Stopwatch display : 2-row indication + dot indication (5X35), Hour, Minute, Second, 1/100-second (100-hour stopwatch), Selectable display of lap/split/running lap modes, Up to 300 lap/split time records
6. Display medium : F-STN
7. Battery : Secondary battery, 1 piece
8. Duration of operation : Approximately 6 months without being recharged after fully charged, under the conditions that the stopwatch is used less than 3 hours and the power save mode is activated for 20 hours and the data communication is carried out 3 times or less per day.
9. IC (Integrated Circuit) : C-MOS-IC, 1 piece
10. Communication function: NFC communication

※The specifications above are subject to change without prior notice, for product improvements.

お客様相談室

通話料無料 0120-612-911

セイコーウォッチ株式会社

<https://www.seikowatches.com/>